

Art. Nr. 3420296
1/6

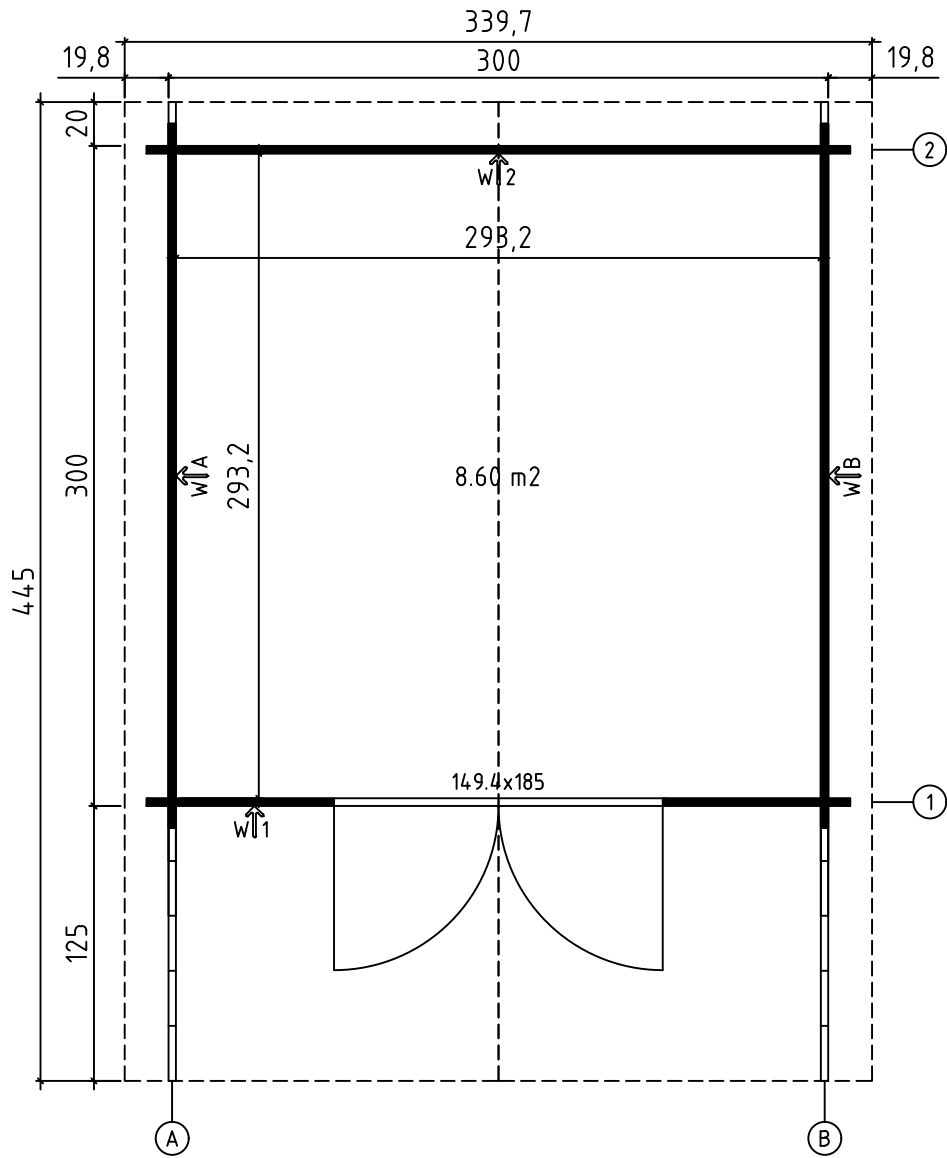

13.02.2024



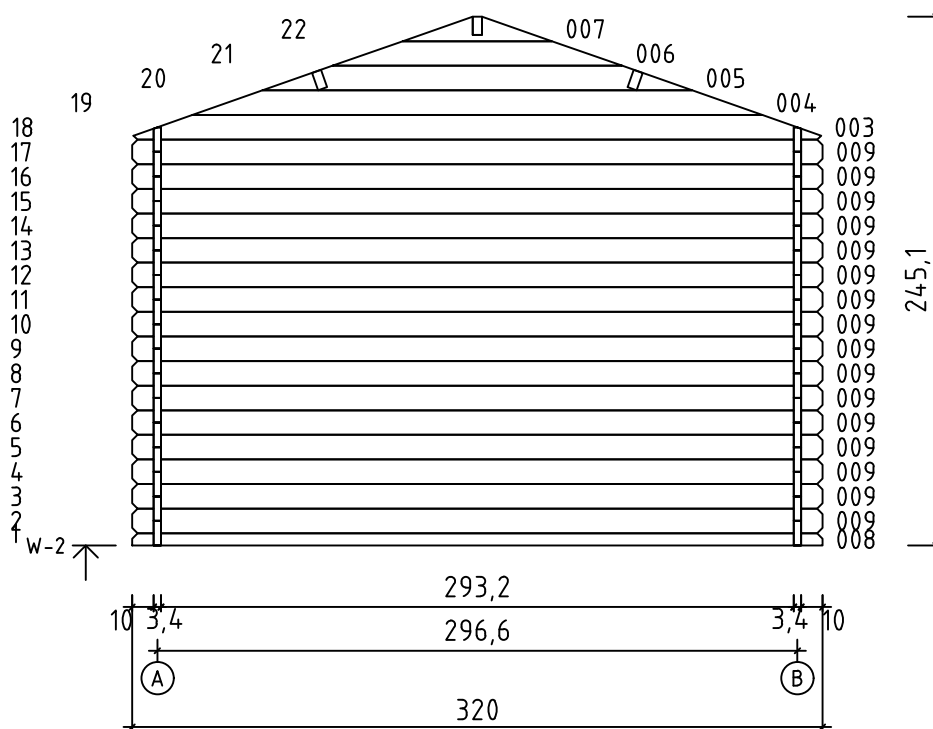
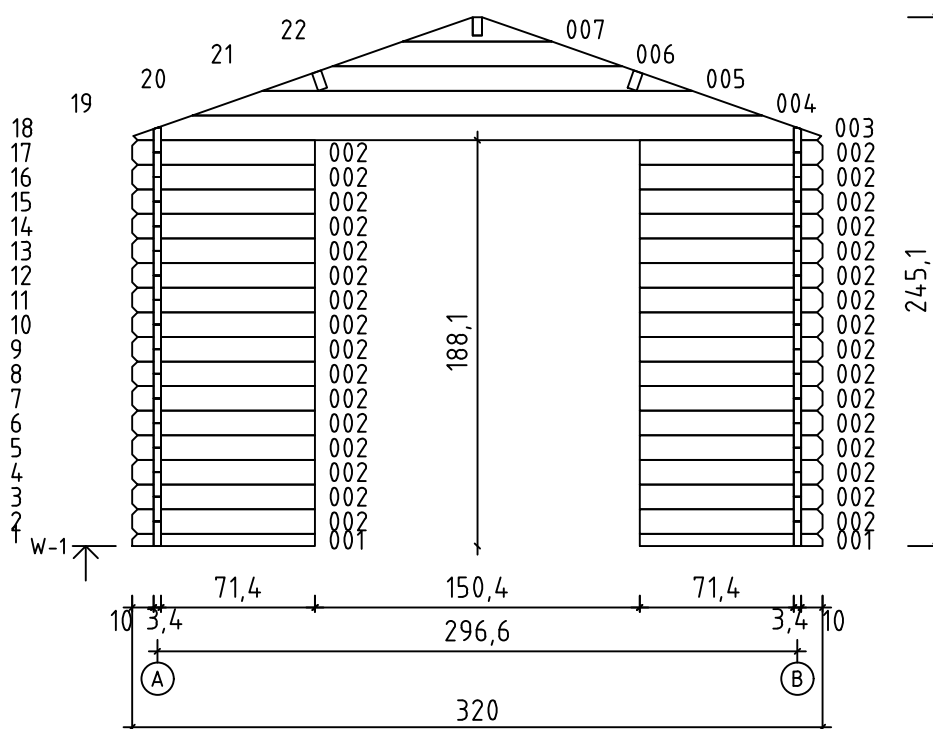

Groundplan - Grundplan - Plan de masse - Planimetria -
Plattegrond - Planimetría - Põhiplaan



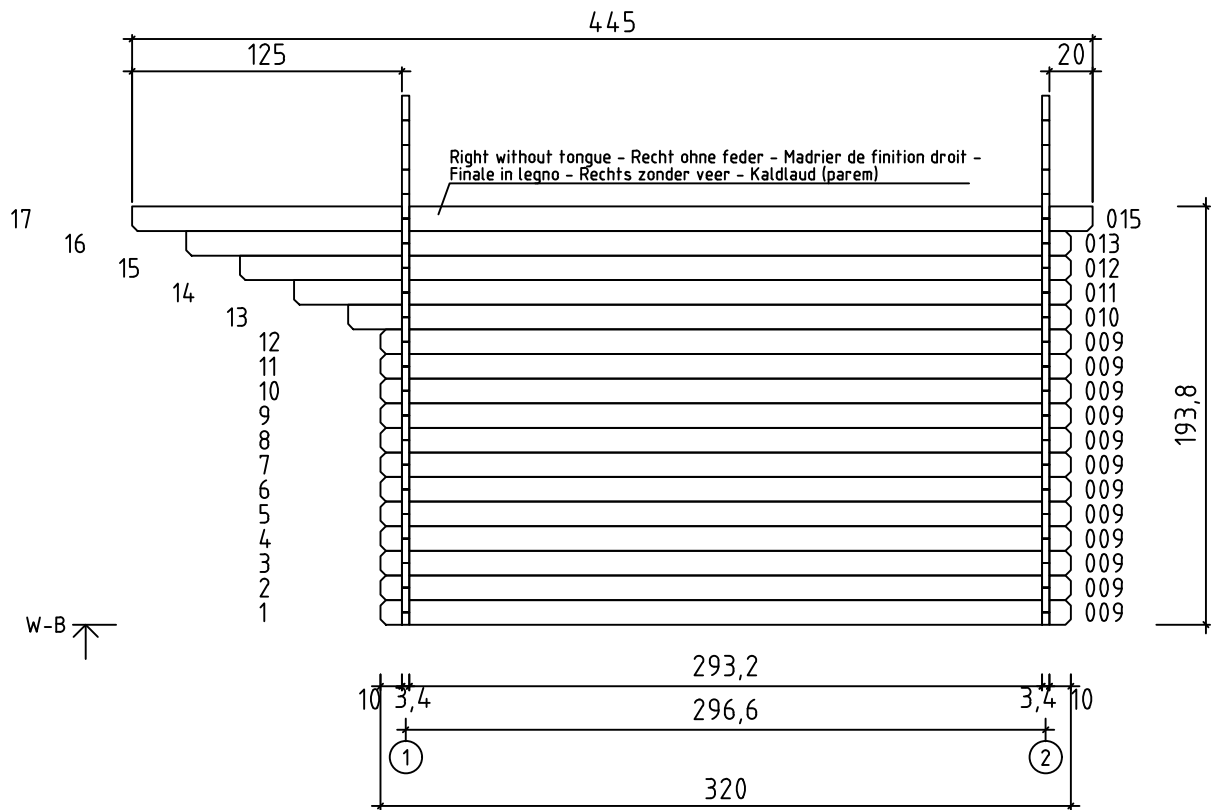
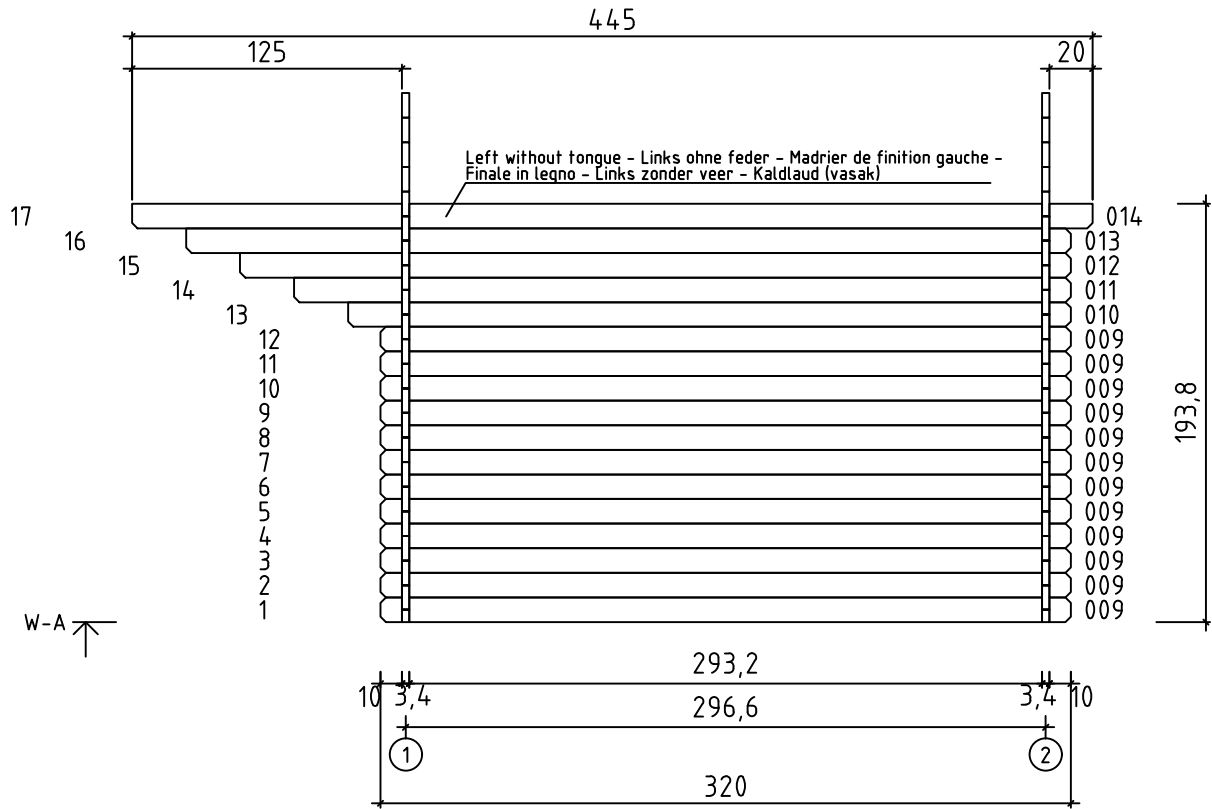

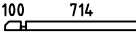
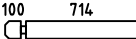
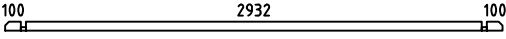
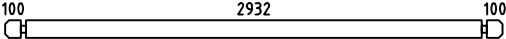
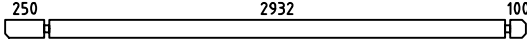
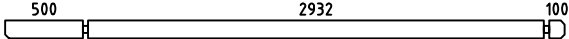
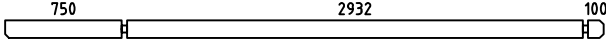
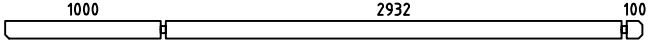
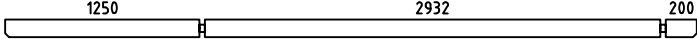
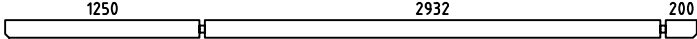
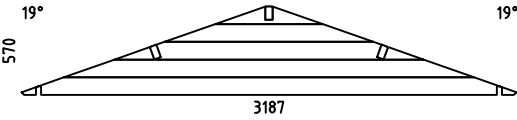
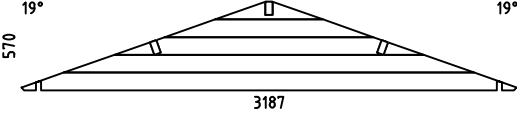
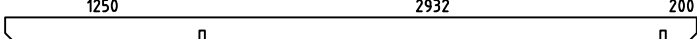

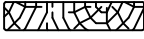
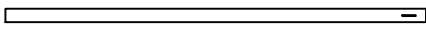
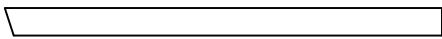

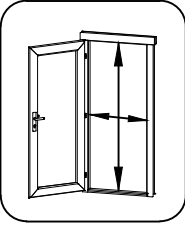
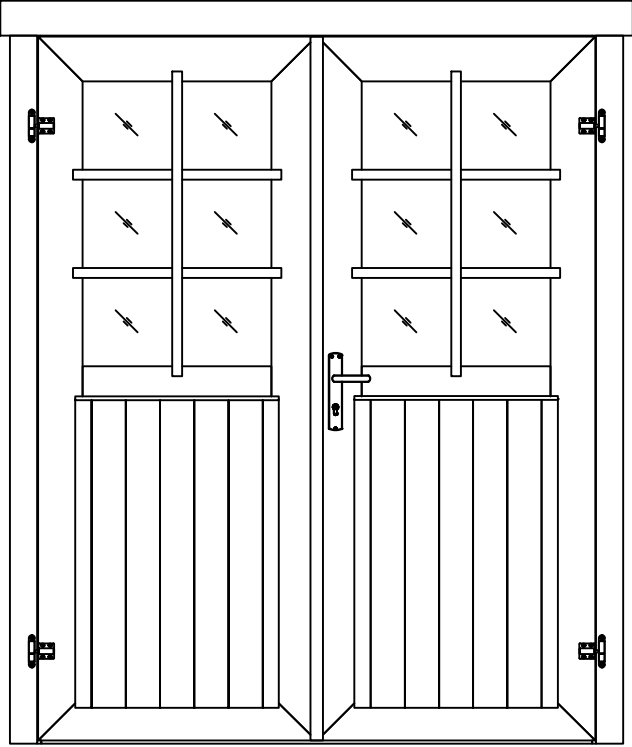

Art. Nr. 3420296

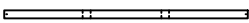
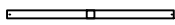

Pos	13.02.2024 Piece list - Stückliste - Liste des pièces - Elementi - Stuklijst - Elementos - Tükítabel Art. Nr. 3420296	5/6	Q	P (mm)	L (mm)
001 17346			2	34x57	848
002 17347			32	34x114	848
008 17350			1	34x57	3200
009 1476			40	34x114	3200
010 43234			2	34x114	3350
011 1478			2	34x114	3600
012 43235			2	34x114	3850
013 43236			2	34x114	4100
014 43237			1	34x120	4450
015 43238			1	34x120	4450
W1-1 35871			1		
W2-1 35871			1		
A-PR1 43239	Roof beam - Dachbalken - Panne de toit - Perlina del tetto - Gordingen / dakbalk - Correa - Pärlin 		3	44x146	4450
RB-1 779	Roof boards - Dachbretter - Voliges - Perlina per tetto - Dakhout - Tablero de tejado - Katuselaud 		100	90x18.5	1800
DPL-1 781	Roofing felt fillet - Dachpappenleiste - Baguette de fixation du feutre bitumeux - Asse per fissaggio guaina bituminosa - Afdeklíjst asfaltpapier - Moldura de fieltro para tejado - Katusepapiliist 		4	18x58	1850
TB4-1 43240	Fascia board - Traufbrett - Bandeau de toit - Finitura lati tetto - Gevellijst - Tablero de alero - Räästalaud 		4	18x58	2225
KFS-1 2249	Storm protection - Sturmleiste - Latte anti-tempete - Protezione anti vento - Stormverankering / beveliging - Moldura antitormenta - Tormikinnitusliist 		4	22x45	2050
GL-1 29410	Gable moulding - Giebelleiste - Planche de rive - Finitura per frontale e retro del tetto - Gevellijst - Tablero de frontón - Viilulaud 		4	18x120	1850
HS8 5105	Screw for gable segment - Schrauben für deckblatt - Vis pour fixation losange de finition - Viti x frontali tetto - Schroef voor gevelpunt segment - Tornillo para rombo - Kruvi rombile 		4	3.5x35	

Pos	19.12.2017 Piece list - Stückliste - Liste des pièces - Elementi - Stuklijst - Tükitalabel 14.94x1850 TUK.2.056.SVP.MX34 SGA+28	1/2	Q	P (mm)	L (mm)
Glass size - Glasgröße - Taille de la vitre - Misura del vetro - Glas afmeting - Klaasi mõõt: 502x750 mm				 1418x1794 mm	
					
1	Upper door jamb - Türrahmen oben - Cadre de porte supérieur - Telaio superiore della porta - Bovendorpel - Ukse ülemine leng		1	72x100	1438
2	Left door jamb - Türrahmen links - Cadre de porte gauche - Telaio montante sinistro della porta - Linkerstijl deurframe - Ukse vasak leng		1	72x80	1850
3	Right door jamb - Türrahmen rechts - Cadre de porte droit - Telaio montante destro della porta - Rechterstijl deurframe - Ukse parem leng		1	72x80	1850
4	Doorstep - Swelle - Barre de seuil - Soglia della porta - Deurdorpel - Lävepak		1	18x24	1418
5	Connection strip - Deckleiste - Baguette de battement - Profilo verticale della porta - Stulpelijst - kokkuvaltsiliist		1	13x32	1812
6	Georgian bars - Sprossen - Croisillons - La griglia georgiana - Raamverdeling - Petteliistud		2	15x25	784
7	Georgian bars - Sprossen - Croisillons - La griglia georgiana - Raamverdeling - Petteliistud		4	15x25	536

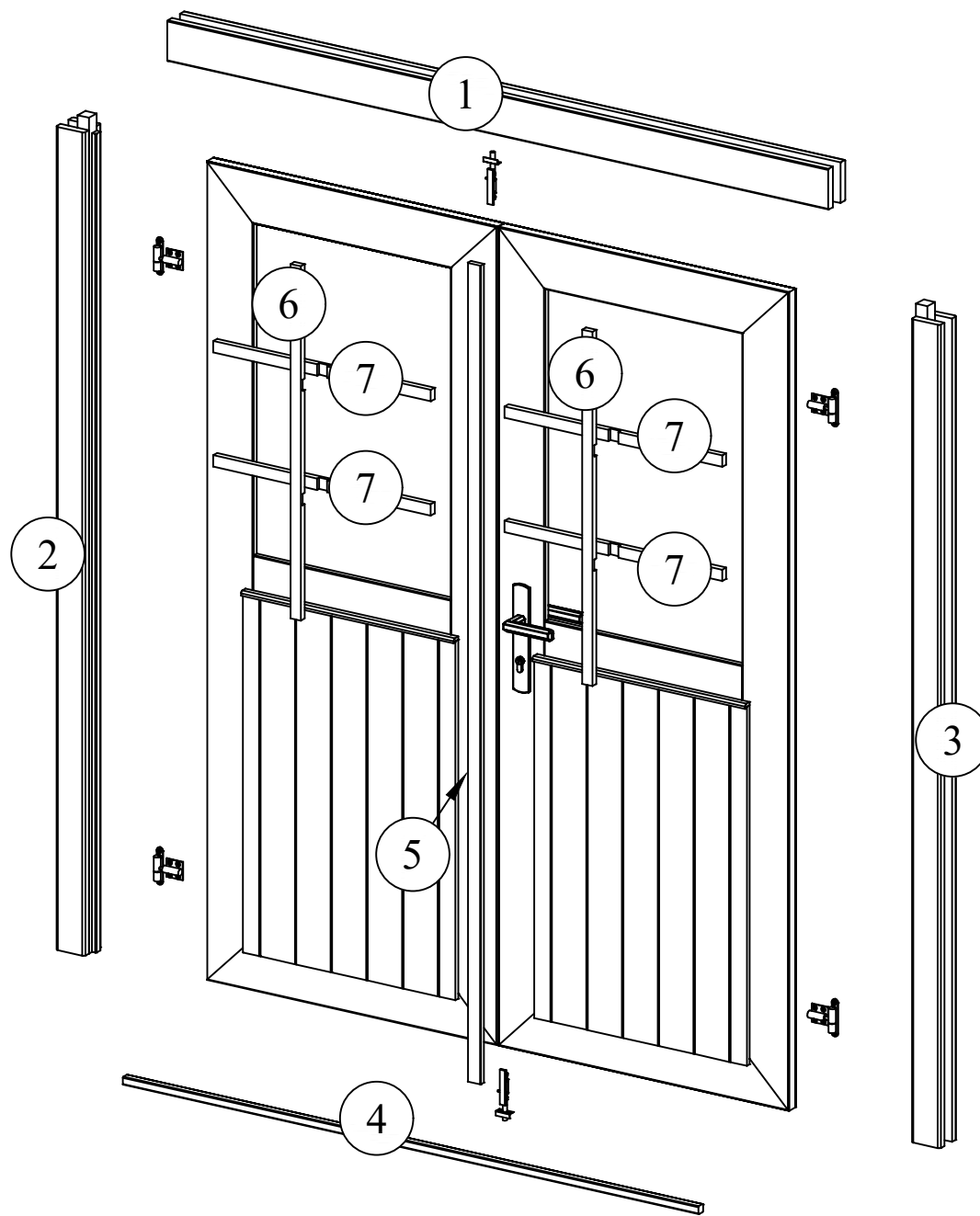

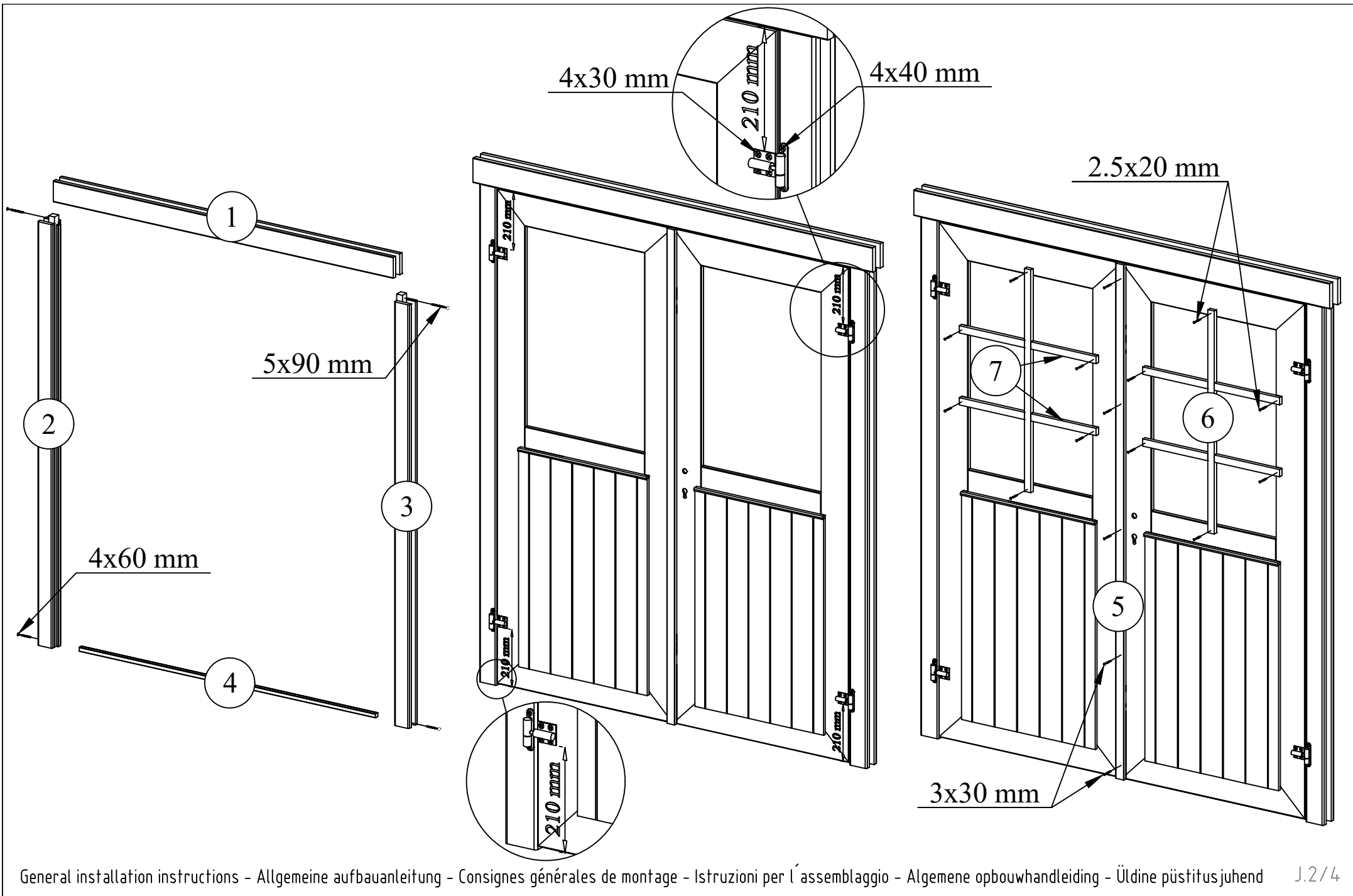

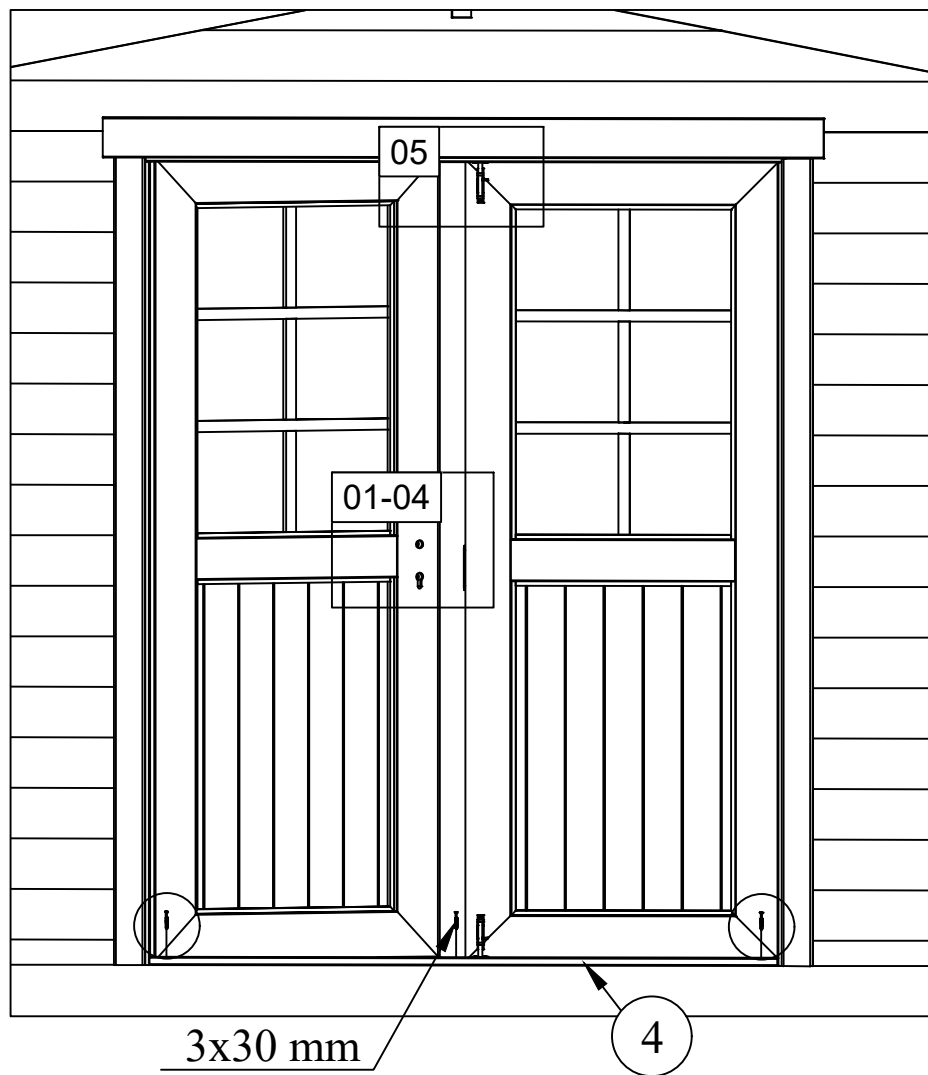

01



04



02



05



03



06

