

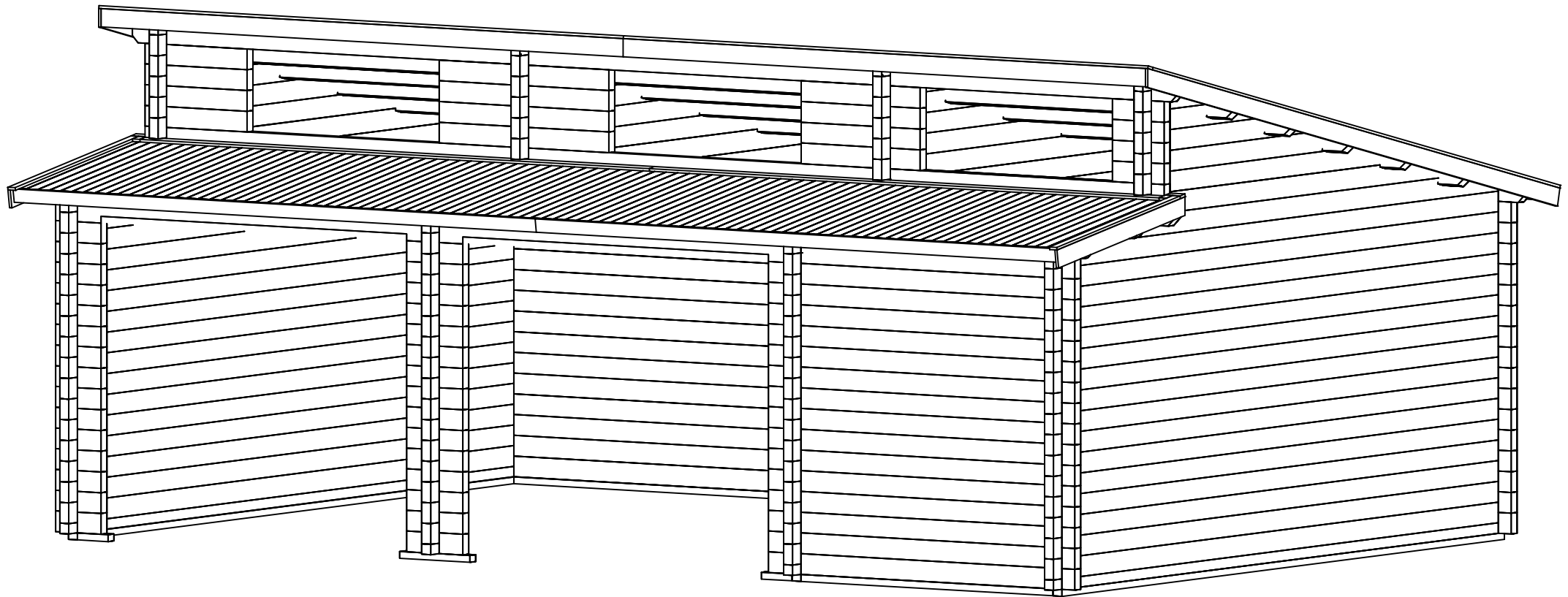









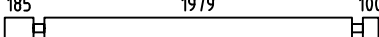
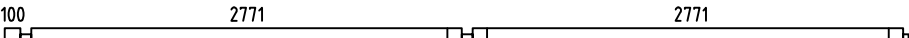
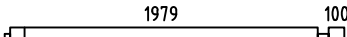
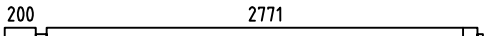
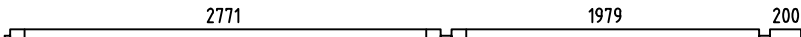
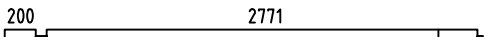
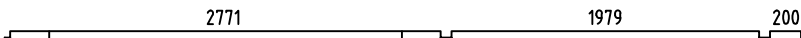

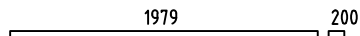
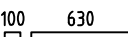

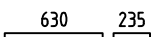

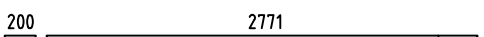

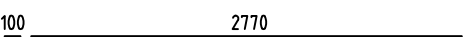

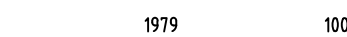
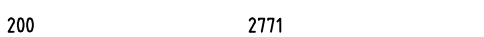
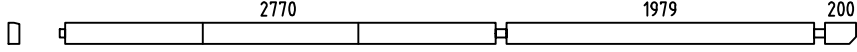
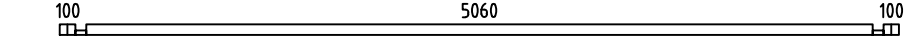
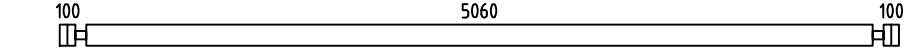
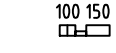
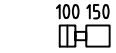
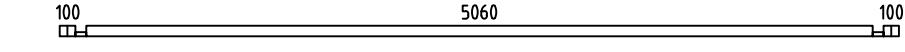
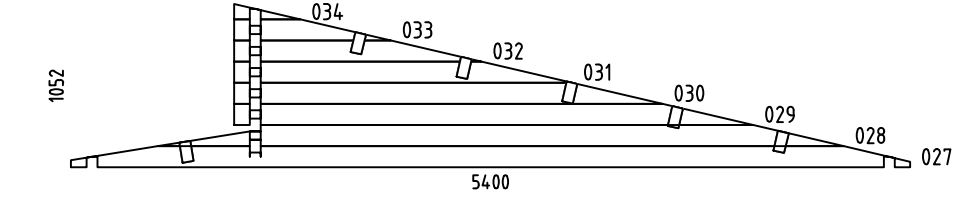
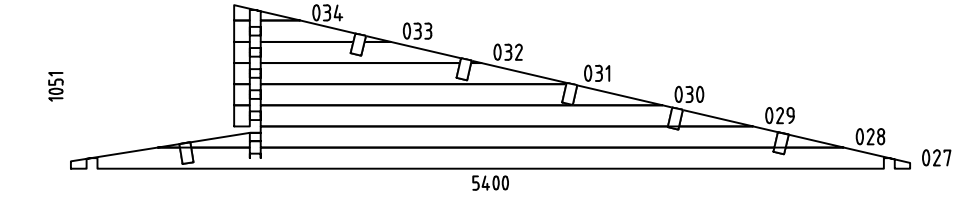
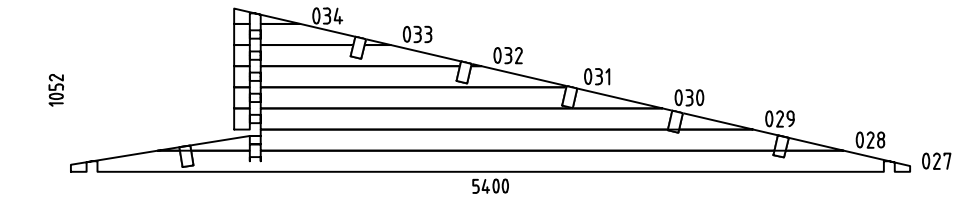
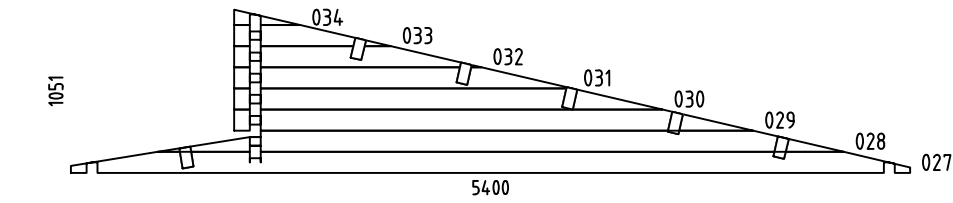
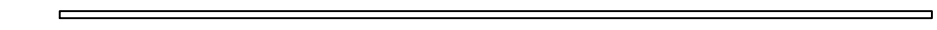
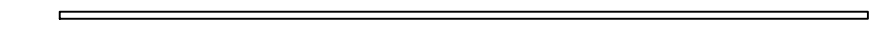
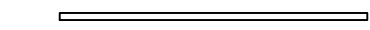





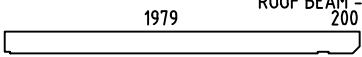





Bespoke garage Hawaii 70

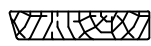
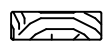

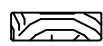



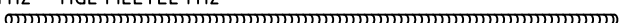
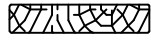

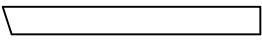
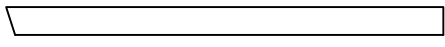





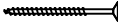
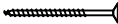
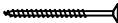
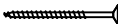
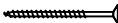

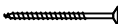
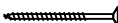
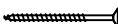
Art.Nr. 130618.1FM









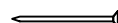

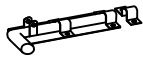
Pos	130618.1FM - Bespoke garage Hawaii 70 Piece list - Stückliste - Liste des pièces	1/6	Q.	P (mm)	L (mm)
001	100 185 		15	70x136	355
002	185 185 		15	70x136	441
003	185 1979 100 		15	70x136	2404
004	100 2771 2771 		1	70x136	5816
005	1979 100 		1	70x136	2184
006	200 2771 		1	70x136	3076
007	2771 1979 200 		1	70x136	5125
008	200 2771 		1	70x136	3076
009	2771 1979 200 		1	70x136	5125
010	200 2771 2770 		1	70x136	5916
011	1979 200 		1	70x136	2284
012	100 630 		4	70x136	800
013	630 630 		3	70x136	1331
014	630 235 		4	70x136	935
015	234 100 		4	70x136	404
016	630 630 		1	70x136	1331
017	200 2771 		1	70x136	3076
018	2771 1979 200 		1	70x136	5125
019	100 2770 		8	70x136	2976
020	2771 1979 100 		8	70x136	5025
021	100 2770 2770 		8	70x136	5816
022	1979 100 		8	70x136	2184
023	200 2771 		1	70x136	3076

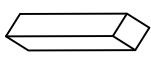
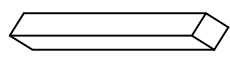
Pos	130618.1FM - Bespoke garage Hawaii 70 Piece list - Stückliste - Liste des pièces	2/6	Q.	P (mm)	L (mm)
024			1	70x136	5125
025			1	70x68	5400
026			50	70x136	5400
035			2	70x68	320
036			28	70x136	320
037			2	70x68	5400
WA-1			1		
WB-1			1		
WC-1			1		
WD-1			1		
IAR3	FOUNDATION - FUNDAMENT - FONDATION 		1	70x45	5611
IAR1	FOUNDATION - FUNDAMENT - FONDATION 		3	70x45	5200
IAR4	FOUNDATION - FUNDAMENT - FONDATION 		2	70x45	1979
IAR6	FOUNDATION - FUNDAMENT - FONDATION 		1	70x45	550
IAR5	FOUNDATION - FUNDAMENT - FONDATION 		2	70x45	240

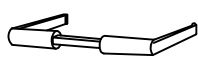
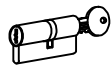
Pos	130618.1FM - Bespoke garage Hawaii 70 Piece list - Stückliste - Liste des pièces	3/6	Q.	P (mm)	L (mm)
IAR2	FOUNDATION - FUNDAMENT - FONDATION 		2	70x45	150
A-PR1	ROOF BEAM - DACHBALKEN - PANNE DE TOIT 		6	70x140	5916
A-PR2	ROOF BEAM - DACHBALKEN - PANNE DE TOIT 		6	70x140	2284
RB-1	ROOF BOARDS - DACHBRETTER - VOLIGES 		92	90x18	4900
RB-2	ROOF BOARDS - DACHBRETTER - VOLIGES 		7	90x18	1471
RB-3	ROOF BOARDS - DACHBRETTER - VOLIGES 		85	90x18	1400
DPL-1	ROOFING FELT FILLET - DACHPAPPENLEISTE - BAGUETTE DE FIXATION DU FEUTRE BITUMEUX 		2	18x58	4000
KPL-1	WALL FINISHING BOARD - ABSCHLUSSBOHLE - MADRIER SUPÉRIEUR DE FINITION 		1	45x57	1978
KPL-2	WALL FINISHING BOARD - ABSCHLUSSBOHLE - MADRIER SUPÉRIEUR DE FINITION 		2	45x57	2000
KPL-3	WALL FINISHING BOARD - ABSCHLUSSBOHLE - MADRIER SUPÉRIEUR DE FINITION 		2	45x57	2770
DRV1-1	ROOF EDGE REINFORCEMENT - DACHRANDVERSTÄRKUNG - CORNIERE DE RENFORT DE BORD DE TOIT 		3	28x34	2733
GL6-1	GABLE MOULDING - GIEBELLEISTE - PLANCHE DE RIVE 		2	18x120	4100
DPL-6	ROOFING FELT FILLET - DACHPAPPENLEISTE - BAGUETTE DE FIXATION DU FEUTRE BITUMEUX 		2	18x58	75
DPL-2	ROOFING FELT FILLET - DACHPAPPENLEISTE - BAGUETTE DE FIXATION DU FEUTRE BITUMEUX 		2	18x58	118
DPL-3	ROOFING FELT FILLET - DACHPAPPENLEISTE - BAGUETTE DE FIXATION DU FEUTRE BITUMEUX 		2	18x58	1470
DPL-4	ROOFING FELT FILLET - DACHPAPPENLEISTE - BAGUETTE DE FIXATION DU FEUTRE BITUMEUX 		2	18x58	4118
DPL-5	ROOFING FELT FILLET - DACHPAPPENLEISTE - BAGUETTE DE FIXATION DU FEUTRE BITUMEUX 		2	18x58	4917
M12-1	TREADED ROD M12 - GEWINDESTANGE M12 - TIGE FILETÉE M12 		8		330
M12-2	TREADED ROD M12 - GEWINDESTANGE M12 - TIGE FILETÉE M12 		8		2000
TB-1	EAVES BOARD - TRAUFBRETT - BANDEAU DE TOIT 		4	18x90	4100
DRV-1	ROOF EDGE REINFORCEMENT - DACHRANDVERSTÄRKUNG - CORNIERE DE RENFORT DE BORD DE TOIT 		6	28x34	2733
GL-1	GABLE MOULDING - GIEBELLEISTE - PLANCHE DE RIVE 		2	18x120	1524
GL-2	GABLE MOULDING - GIEBELLEISTE - PLANCHE DE RIVE 		2	18x120	4975

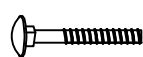
Pos	130618.1FM - Bespoke garage Hawaii 70 Piece list - Stückliste - Liste des pièces	4/6	Q.	P (mm)	L (mm)
KL4	LENGTHENING BOLT FOR TREADED ROD - VERLÄNGERUNGSMUTTER FÜR GEWINDESTANGE - MANCHON DE RACCORDEMENT DE TIGE FILETÉE		8		
KL1	DRIVE NUT TREADED ROD - EINSHLAGMUTTER FÜR GEWINDESTANGE - ÉCROU A FRAPPER POUR TIGE FILITÉE		8		
KL2	NUT FOR TREADED ROD - MUTTER FÜR GEWINDESTANGE - ÉCROU POUR TIGE FILETÉE		8		
KL3	PLAIN WASHER TREADED ROD - UNTERLEGSSCHEIBE FÜR GEWINDESTANGE - RONDELLE PLATE POUR TIGE FILETÉE		8		
HS22	SCREW FOR FIXING DOOR TO THE WALL - SCHRAUBE ZUR BEFESTIGUNG TÜR-ZARGE MIT WAND - VIS DE FIXATION DORMANT DE PORTE		8	3.5x50	
HS16	SCREW FOR GABLE MOULDING - SCHRAUBEN FÜR GIEBELLEISTE - VIS DE FIXATION POUR PLANCHE DE RIVE		66	3.5x50	
HS3	SCREW FOR DOOR FILLET - SCHRAUBE ZUR BEFESTIGUNG TÜRLEISTE - VIS D'ASSEMBLAGE DU CADRE DE PORTE		12	3x30	
HS85	SCREW FOR LATCH BOLT FOR GATE - SCHRAUBE FÜR DOPPELTÜRFEESTSTELLRIEGEL - VIS DE FIXATION DE LA SERRURE DE PORTE		24	4x25	
HS32	SCREW FOR EAVES BOARDS - SCHRAUBEN FÜR TRAUFBRETTEN - VIS DE FIXATION POUR BANDEAU DE TOIT		54	4x40	
HS26	SCREW FOR ROOF EDGE REINFORCEMENT - SCHRAUBEN FÜR DACHRANDVERSTÄRKUNG - VIS POUR RENFORT DE BORD DE TOIT		54	4x40	
HS39	SCREW FOR FUNDAMENT - SCHRAUBEN ZUR BEFESTIGUNG FUNDAMENT - VIS POUR FONDATION		10	5x120	
HS42	SCREW FOR GABLE - SCHRAUBEN FÜR GIEBEL - VIS POUR FIXATION DES PIGNONS		48	5x120	
HS39	SCREW FOR FUNDAMENT - SCHRAUBEN ZUR BEFESTIGUNG FUNDAMENT - VIS POUR FONDATION		14	5x90	
HS81	SCREW FOR ROOF EDGE REINFORCEMENT - SCHRAUBEN FÜR DACHRANDVERSTÄRKUNG - VIS POUR FIXATION CORNIERE RENFORT DE BORD DE TOIT		23	5x90	
HS41	SCREW FOR DOOR JAMB - SCHRAUBE FÜR TÜRRAHMEN - VIS DE FIXATION POUR MONTANT DE PORTE		8	5x90	
HS40	SCREW FOR 1. WALL BEAM - SCHRAUBE FÜR 1. BOHLENREIHE - VIS DE FIXATION DES FONDATIONS		14	6x150	
HS48	SCREW FOR GABLE - SCHRAUBEN FÜR GIEBEL - VIS POUR FIXATION DES PIGNONS		17	6x180	
HS44	SCREW FOR RAFTER - SCHRAUBEN ZUR BEFESTIGUNG DACHSPARREN - VIS POUR CHEVRON		18	6x180	
HS47	SCREW FOR GATE HINGES - SCHRAUBEN FÜR TORRIEGEL - VIS POUR LES CHARNIERES DE PORTE		72	6x40	
HS51	SCREW FOR BEAM HOLDER - SCHRAUBEN FÜR BALKENHALTER - VIS DE FIXATION SUPPORT U GALVANISÉ		12	4.5x35	
SH70	HAMMER BLOCK - SCHLAGHOLZ - CALLE DE FRAPPE		2		
NFD	ZN NAIL FOR ROOFING FELT FILLET - ZN NÄGEL FÜR DACHPAPPENLEISTE - POINTE POUR BAGUETTE FIXATION FEUTRE BITUMEUX		70	2x40	
NF2	ZN NAIL FOR ROOF - ZN NÄGEL FÜR DACHBRETTEN - POINTE POUR TOIT		950	2x50	

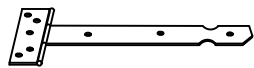
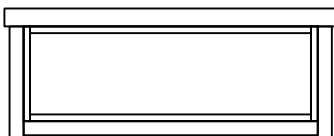
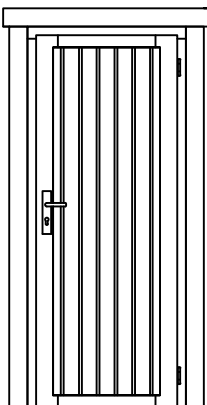
Pos	130618.1FM - Bespoke garage Hawaii 70 Piece list - Stückliste - Liste des pièces	5/6	Q.	P (mm)	L (mm)
ORZ	MONTAGE SET FOR DOORS AND WINDOWS - MONTAGE-SET FÜR TÜREN UND FENSTER - JEU DE MONTAGE PORTES ET FENETRES		1		
TL	LATCH BOLT FÜR DOUBLE DOOR - TORRIEGEL - LOQUET POUR DOUBLE PORTE		4		
TLV	STRIKER PALTE - SCHLISSBLECH - PARTIE DE RECEPTION DU LOQUET HAUT DE PORTE		2		
SP2	HIDDEN FIXING - HOLZDÜBEL - TOURILLON BOIS		2		
SP1	HIDDEN FIXING - HOLZDÜBEL - TOURILLON BOIS		25		
BHV	BEAM HOLDER - BALKENHALTER - SUPPORT EN U GALVANISÉ		12		
TS4	SET OF DOOR LOCK COVERS - SCHLOSSBLENDEN - SET DE GARNITURES DE SERRURE DE PORTE		2		
TS3	DOOR HANDLE FITTINGS-TÜRGRIF - SET DE GARNITURES DE SERRURE DE PORTE		2		
TS6	CYLINDER LOCK - ZYLINDERSCHLOSS - CYLINDRE DE SERRURE		2		
TS14	NUT FOR GATE HINGES - SCHRAUBENMUTTER FÜR TORRIEGEL - ECROU POUR LES CHARNIERES DE PORTE		16	D6	
TS11	BOLT FOR GATE HINGES - BOLZEN FÜR TORRIEGEL - BOULON POUR LES CHARNIERES DE PORTE		8	6x130	
TS12	BOLT FOR GATE HINGES - BOLZEN FÜR TORRIEGEL - BOULON POUR LES CHARNIERES DE PORTE		8	6x60	
TS13	WASHER FOR GATE HINGES - DICHTSCHEIBE FÜR TORRIEGEL - RONDELLE POUR LES CHARNIERES DE PORTE		16	D6	
TRL	GATE HINGES - TORRIEGEL - CHARNIERES DE PORTE		8		
2+ A.0M	WINDOW - FENSTER - FENETRE 1500x510 		3		
2+ U.2LP	DOOR - TÜR - PORTE 827x1933 		1		

GROUNDPLAN - GRUNDPLAN - PLAN DE MASSE

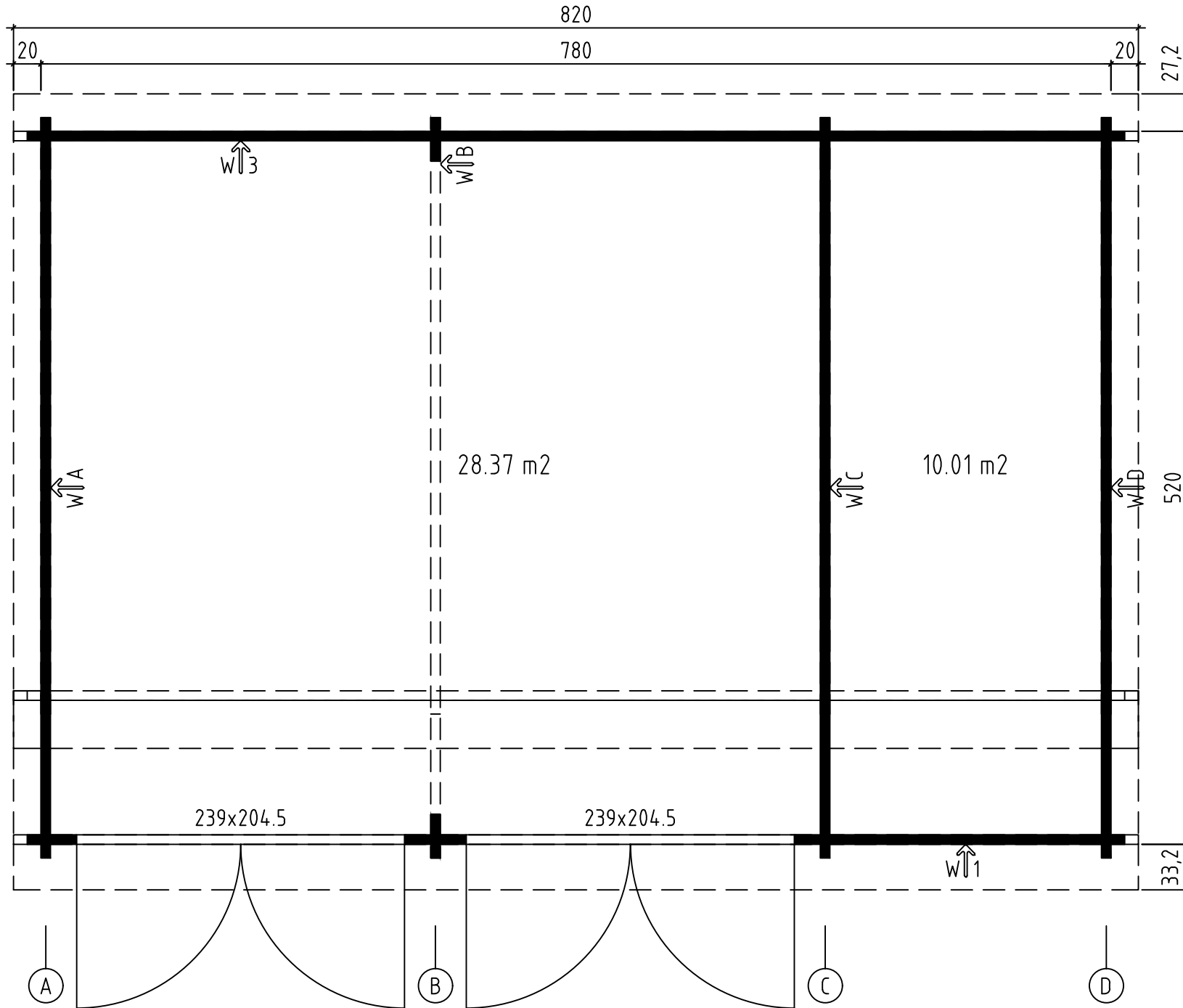

FOUNDATION - FUNDAMENT - FONDATION

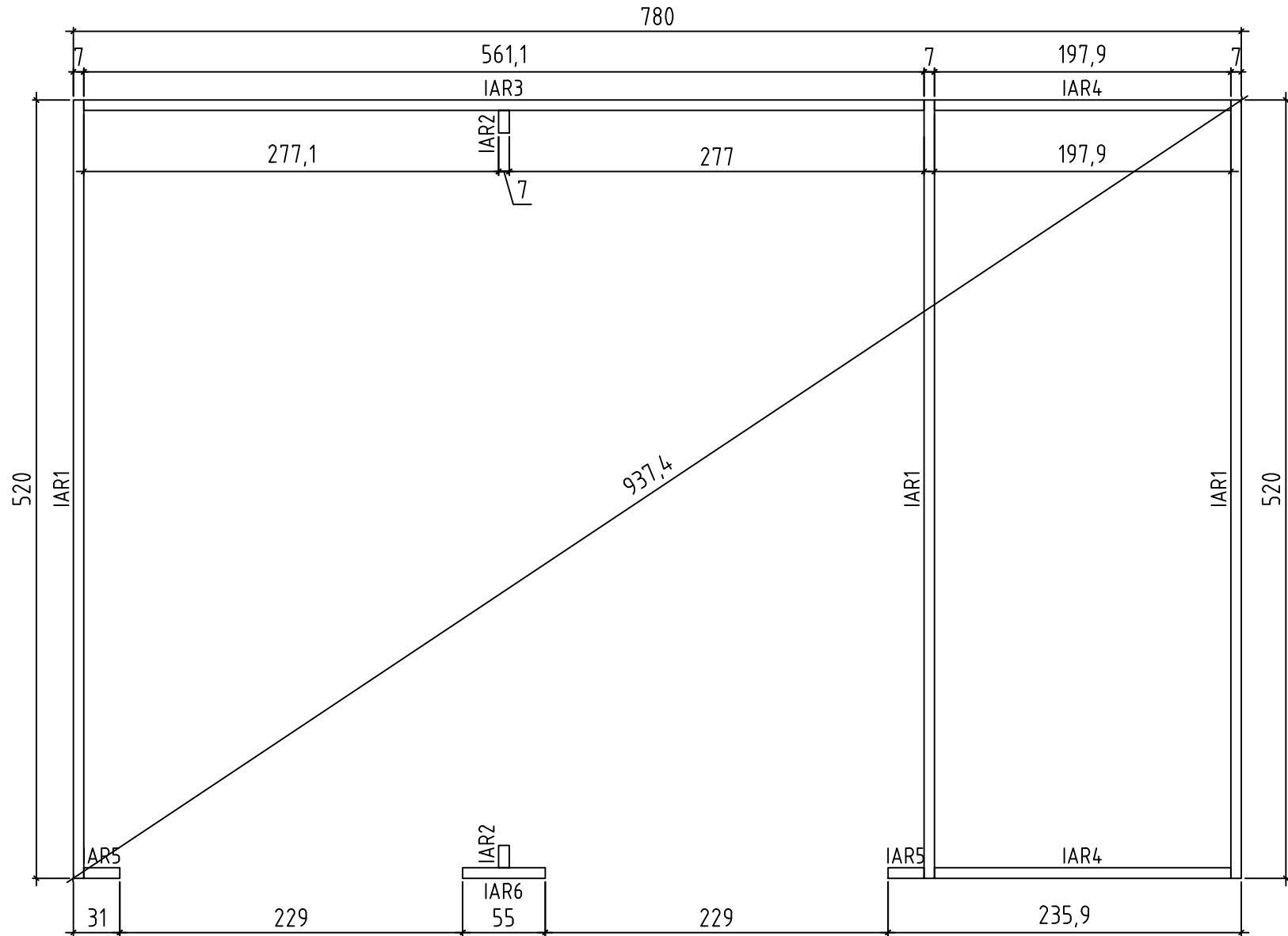

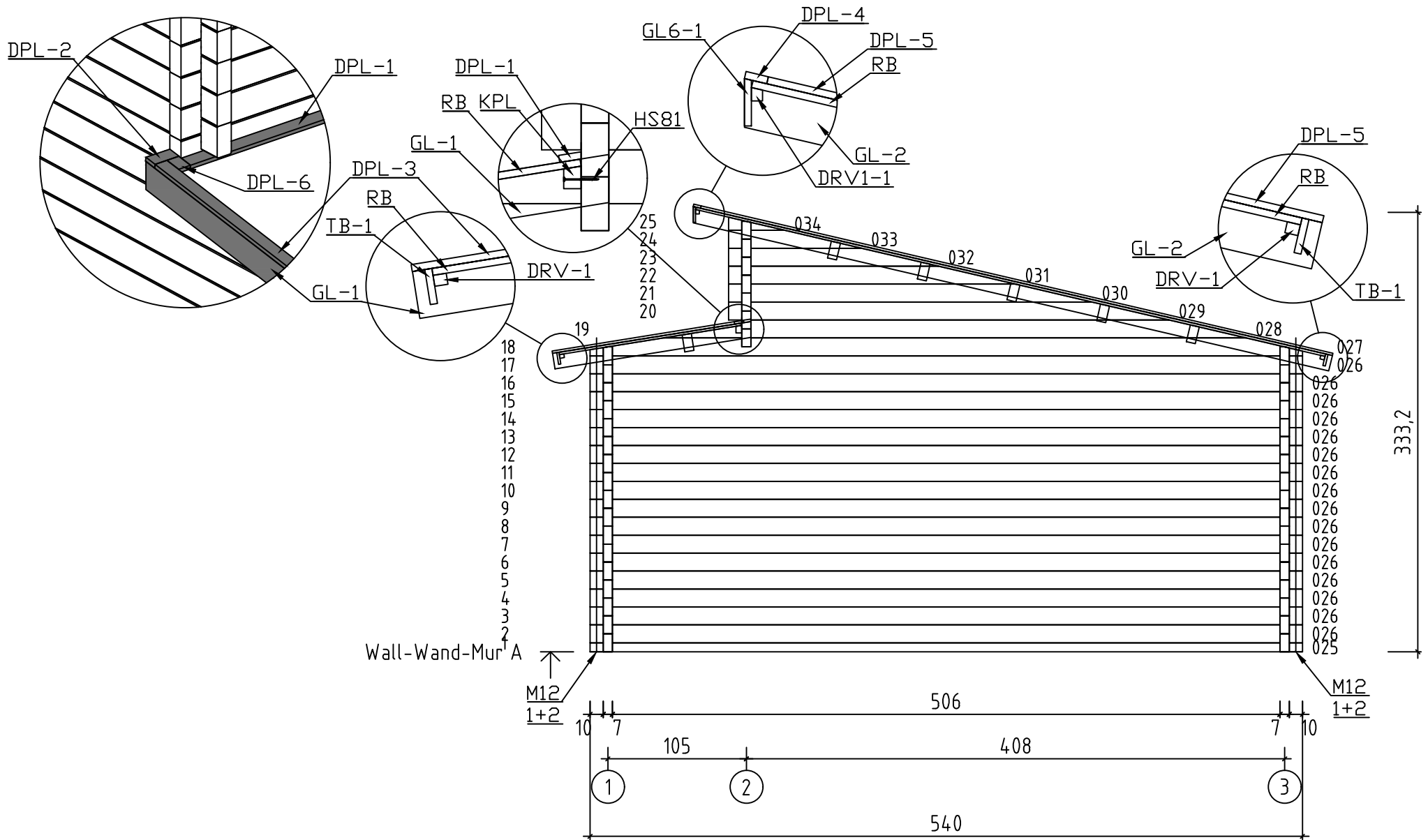

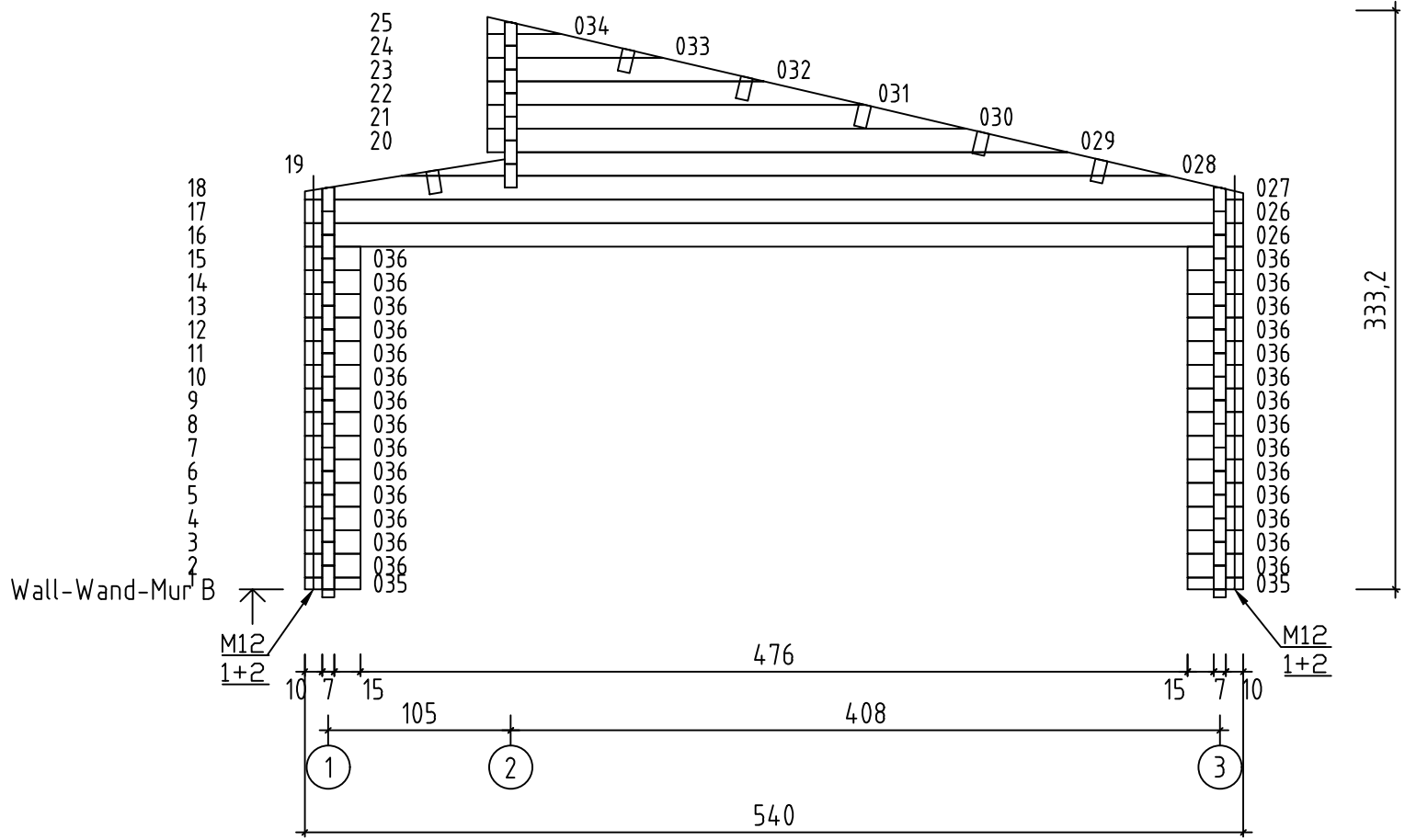

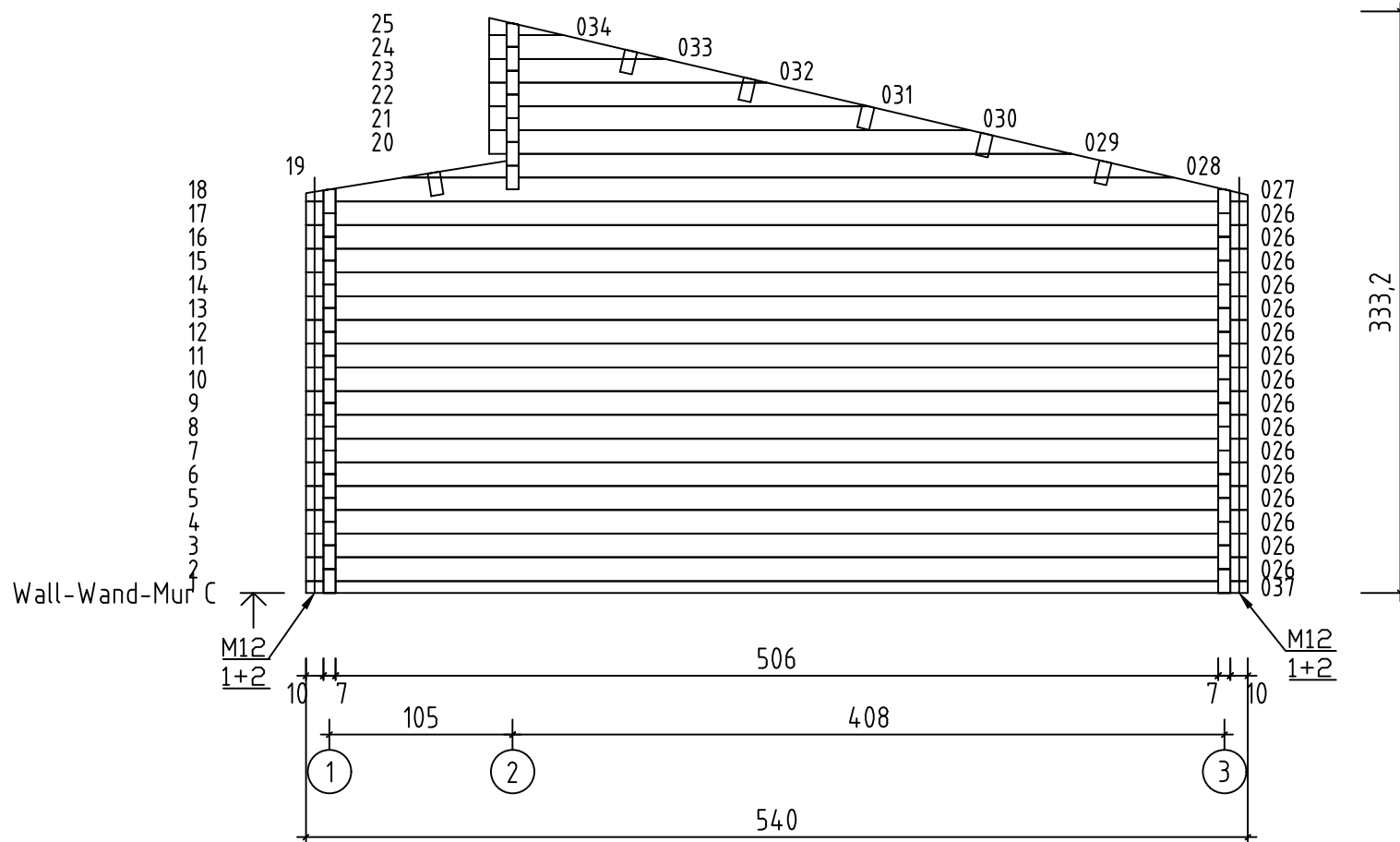

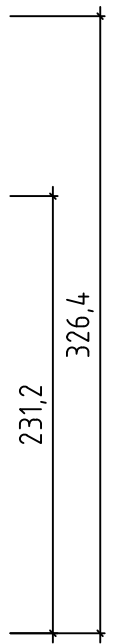
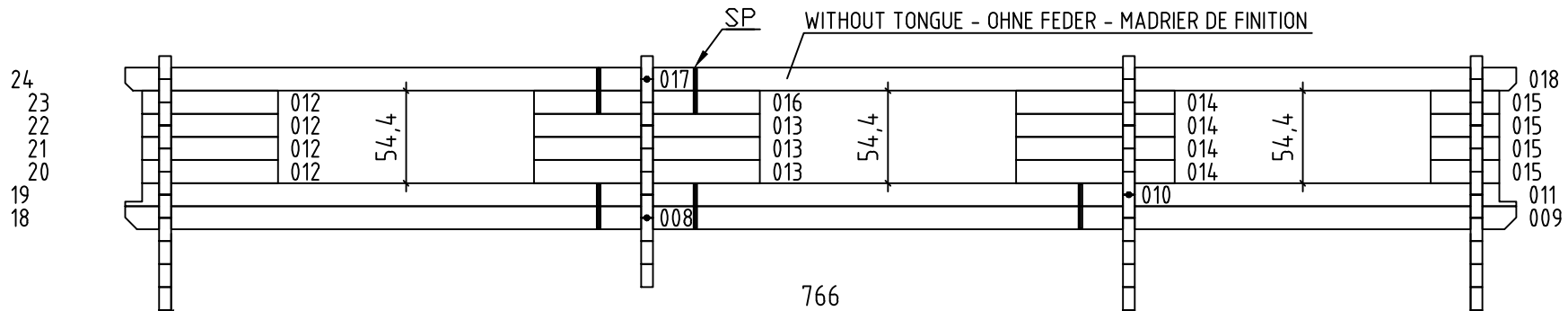

Wall-Wand-Mur 2 ↗

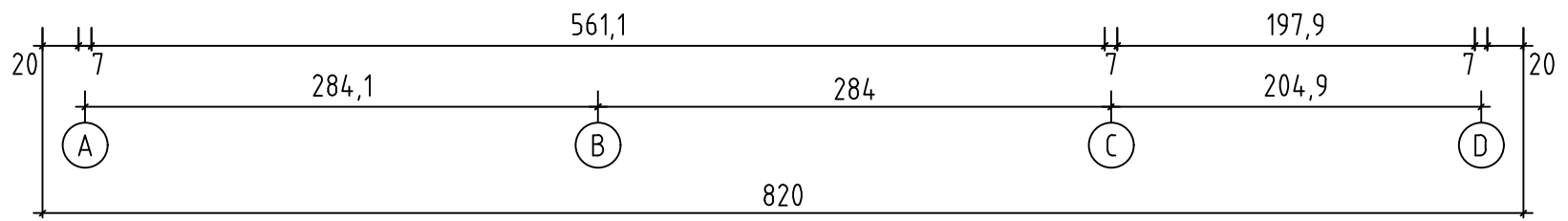

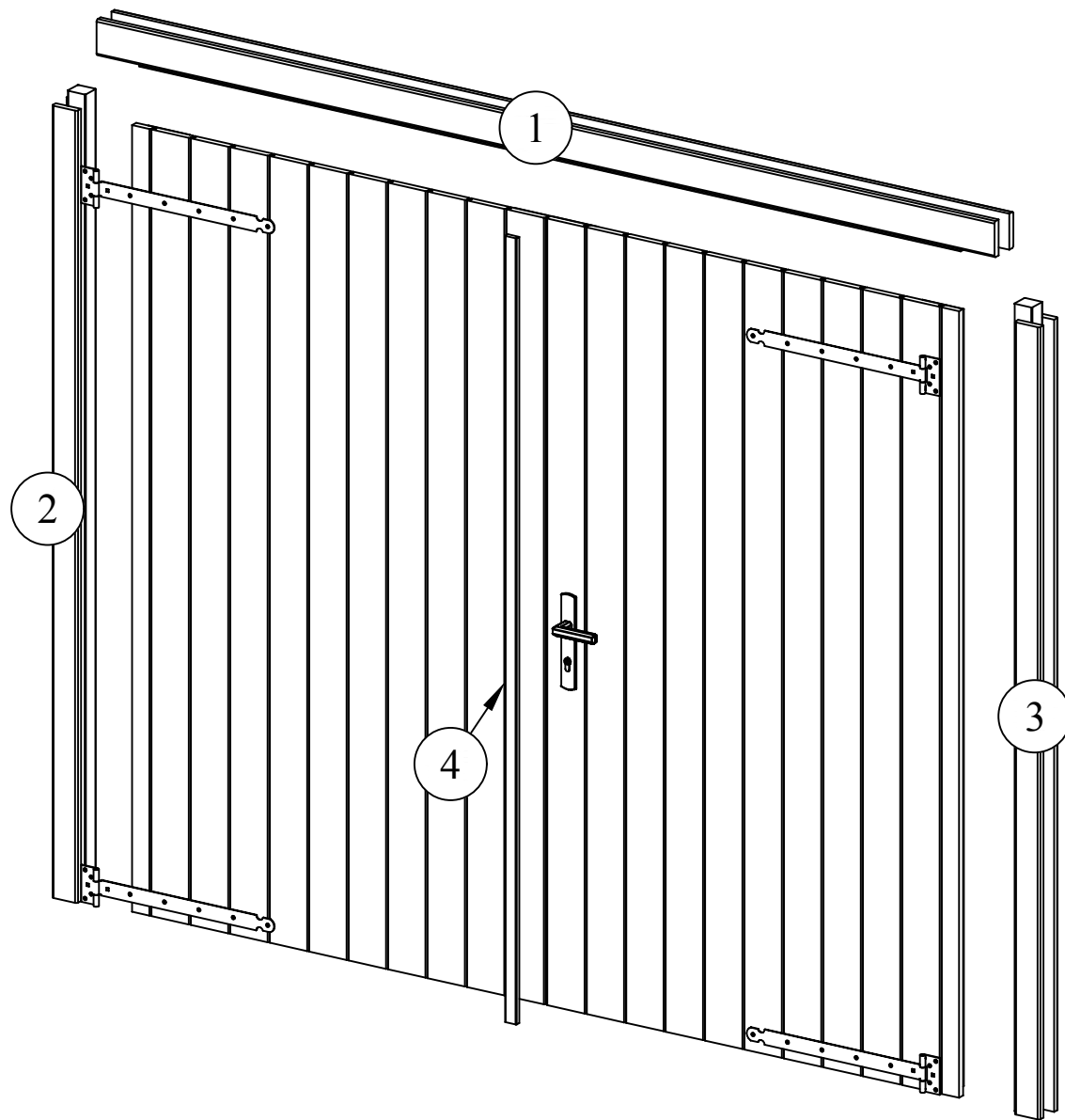

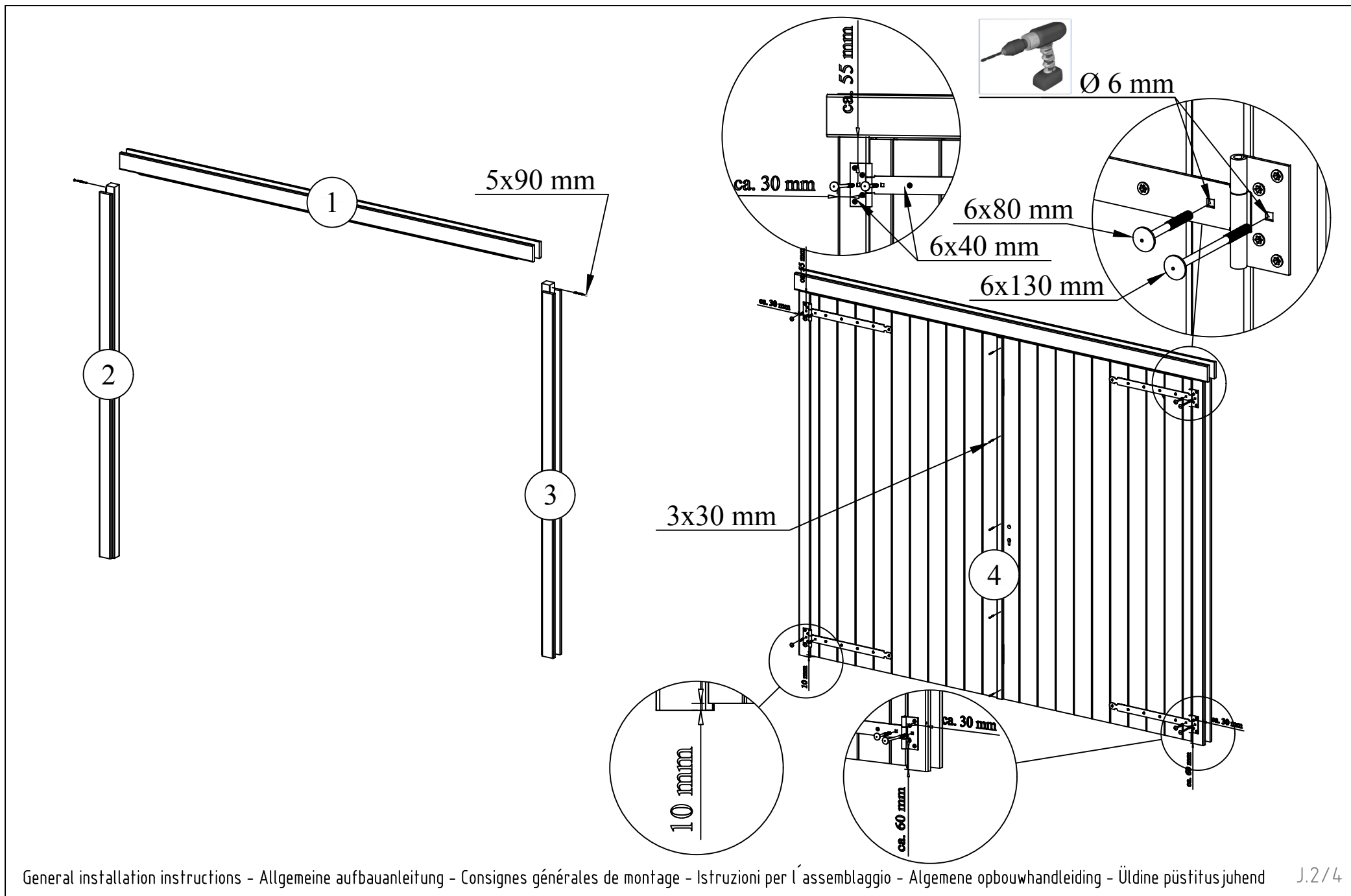

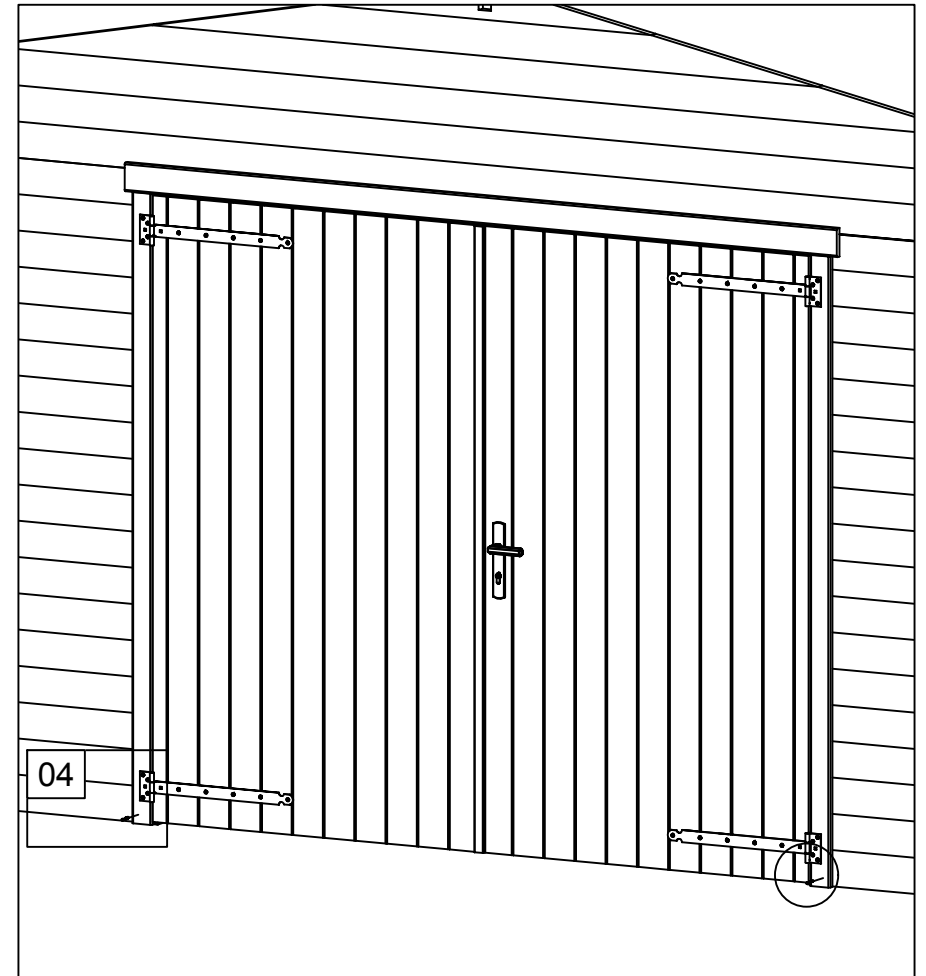
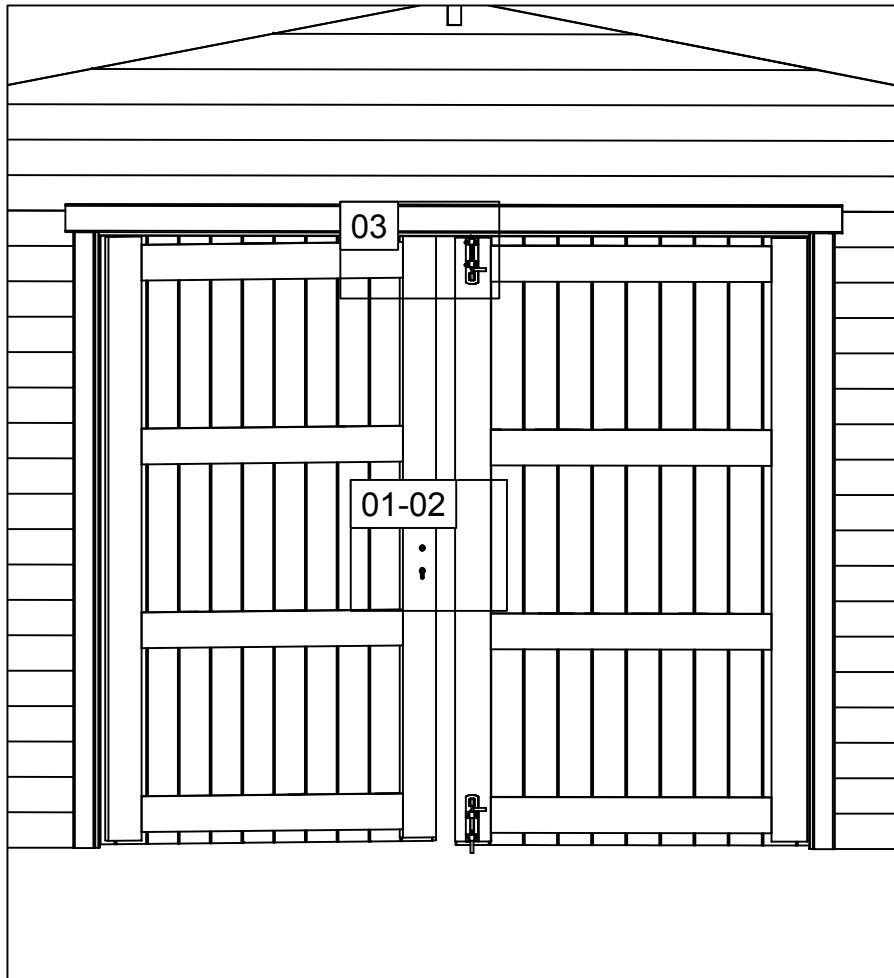

01

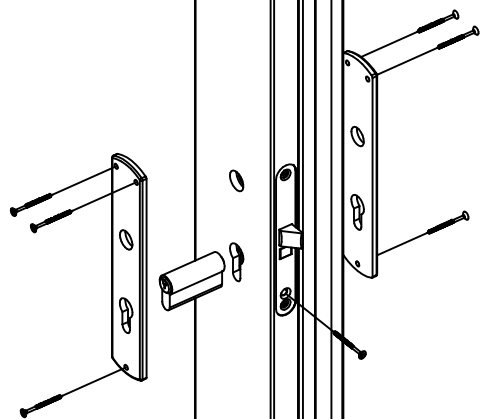

03



Ø 10 mm

4x25 mm

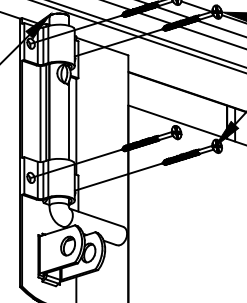

02

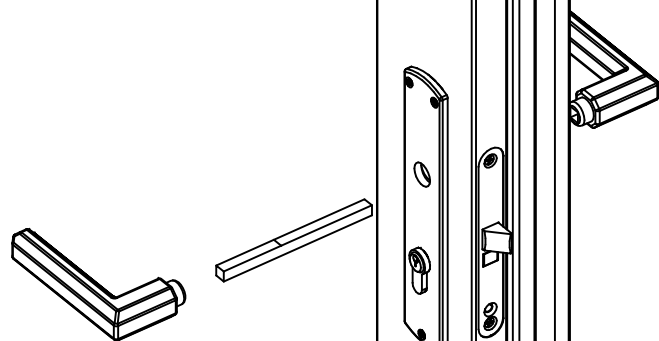

04

3.5x50 mm



