

Art. Nr. 2845196

1/6



30.10.2023

Art. Nr. 2845196



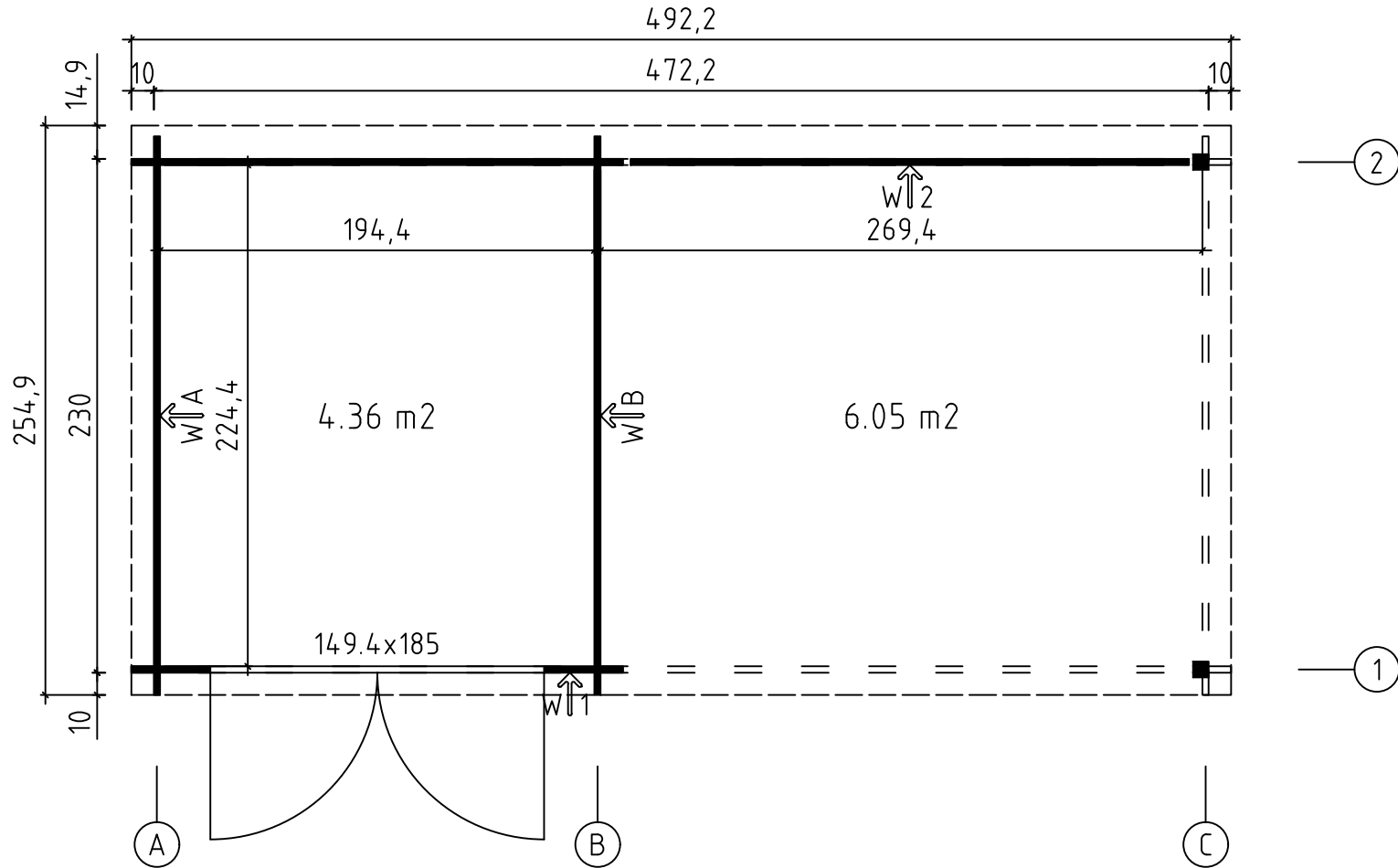

Groundplan - Grundplan - Plan de masse - Planimetria -  
Plattegrond - Põhiplaan



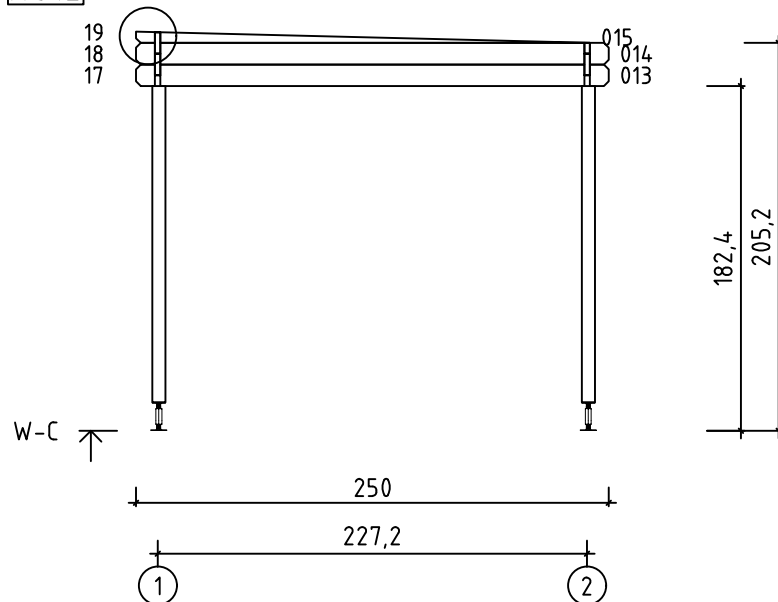
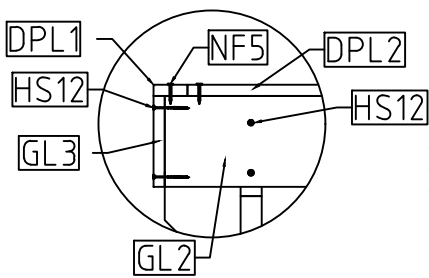
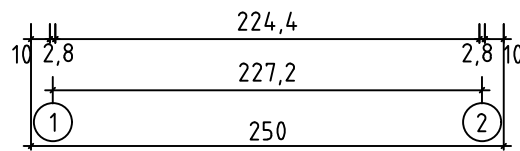
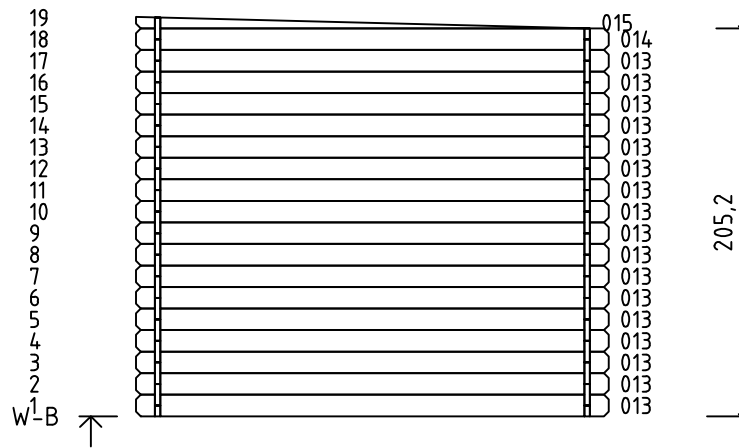
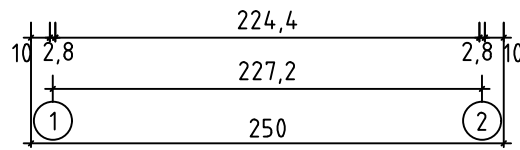
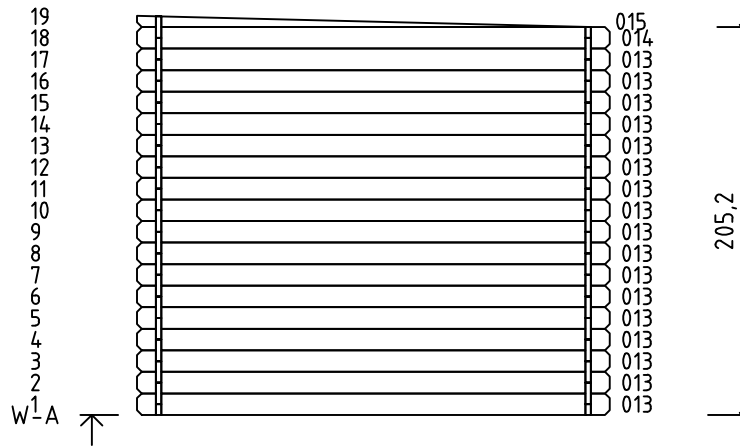



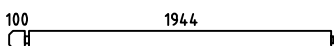
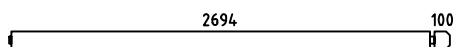
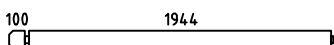
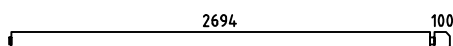
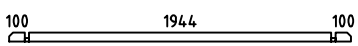
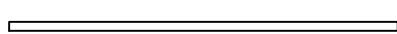
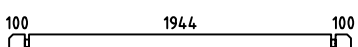
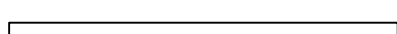
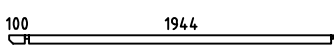
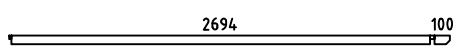
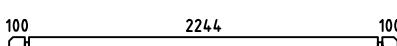
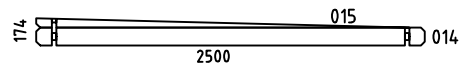
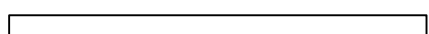
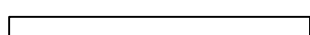
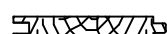
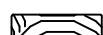
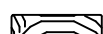
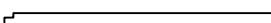
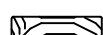





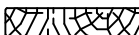
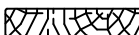
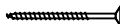
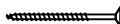
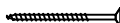





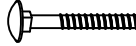

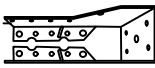

Art. Nr. 2845196

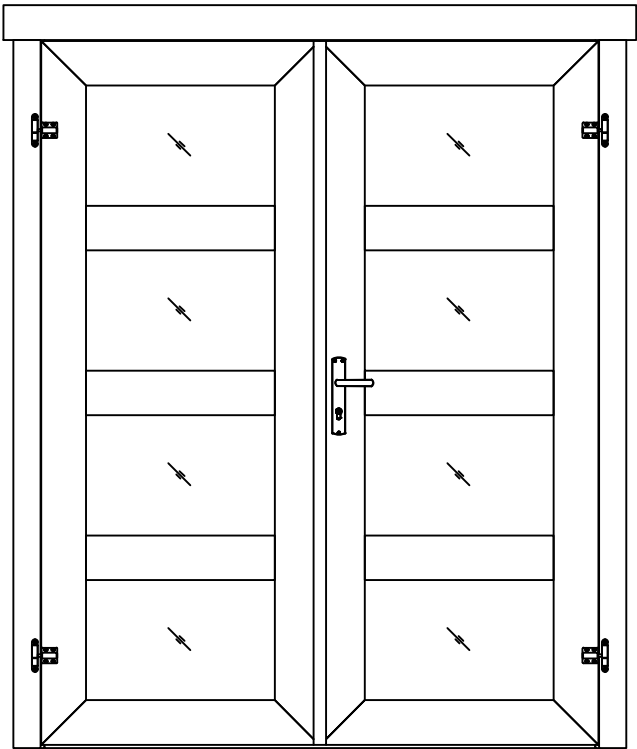
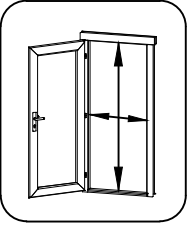

Pos	30.10.2023 Piece list - Stückliste - Liste des pièces - Elementi - Stuklijst - Tükítabel Art. Nr. 2845196	5/6	Q	P (mm)	L (mm)
001			2	28x57	348
002			32	28x114	348
003			2	28x114	2086
004			2	28x114	2836
005			1	28x114	2086
006			1	28x114	2836
007			1	28x57	2200
008			1	28x57	2500
009			16	28x114	2200
010			16	28x114	2500
011			1	28x55	2086
012			1	28x55	2836
013			35	28x114	2500
WA-1 WB-1 WC-1			1 1 1		
A-PR2	Roof beam - Dachbalken - Panne de toit - Perlina del tetto - Gordingen / dakbalk - Pärlin 		3	44x146	2686
A-PR1	Roof beam - Dachbalken - Panne de toit - Perlina del tetto - Gordingen / dakbalk - Pärlin 		3	44x146	1936
	Roof boards - Dachbretter - Voliges - Perlina per tetto - Dakhout - Katuselaud 		55	90x15.5	2550
DPL1	Roofing felt fillet - Dachpappenleiste - Baguette de fixation du feutre bitumeux - Asse per fissaggio guaina bituminosa - Afdeklijst asfaltpapier - Katusepapiilist 		2	15x45	2476
DPL2	Roofing felt fillet - Dachpappenleiste - Baguette de fixation du feutre bitumeux - Asse per fissaggio guaina bituminosa - Afdeklijst asfaltpapier - Katusepapiilist 		2	15x45	2570
P	Post - Pfosten - Poteau - Piede registrabile - Stijl - Post 		2	70x70	1782
DRV-1	Roof edge reinforcement - Dachrandverstärkung - Corniere de renfort de bord de toit - Rinforzo x tetto - Dakrand versterking - Räästatugevdus 		2	15x45	2461
HP	H-profile - H-profiils - Profile H - Profilo ad H - H-profiel - H-profiil 		1	58x90	1935

Pos	30.10.2023 Piece list - Stückliste - Liste des pièces - Elementi - Stuklijst - Tükítabel Art. Nr. 2845196 6/6	Q	P (mm)	L (mm)
KFS-1	Storm protection - Sturmleiste - Latte anti-tempete - Protezione anti vento - Stormverankering / beveiliging - Tormikinnitusliist 	4	22x45	2050
KFS-2	U-profile - U-profils - Profile u - Profilo ad u - U-profiel - U-profiil 	1	28x58	1850
GL1	Gable moulding - Giebelleiste - Planche de rive - Finitura per frontale e retro del tetto - Gevellijst - Viilulaud 	1	15x120	2100
GL2	Gable moulding - Giebelleiste - Planche de rive - Finitura per frontale e retro del tetto - Gevellijst - Viilulaud 	2	15x120	2600
GL3	Gable moulding - Giebelleiste - Planche de rive - Finitura per frontale e retro del tetto - Gevellijst - Viilulaud 	1	15x120	2852
HS9	Screw for u-profile - Schraube zur befestigung u-profils - Vis a tete fraisée pour profil u - Vite per profilo ad u - Schroef ter bevestiging u-profiel - Kruvi U-profiilile 	3	3.5x50	
HS4	Screw for roof edge reinforcement - Schrauben für dachrandverstärkung - Vis pour fixation corniere renfort de bord de toit - Viti x rinforzo bordo tetto - Schroef voor dakrand versterking - Kruvi räästatugevdusele 	12	3x30	
HS11	Screw for beam holder - Schrauben für balkenhalter - Vis de fixation support "u" galvanisé - Vite per trave di sostegno - Schroef voor bevestiging balkhouder (gordingschoen) - Kruvi talakingale 	144	4x30	
HS12	Screw for gable moulding - Schrauben für giebelleiste - Vis pour fixation planche de rive - Vite per fissare finiture davanti e dietro del tetto - Schroef voor gevellijst - Kruvi viilulauale 	20	4x40	
HS13	Screw for h-profile - Schraube zur befestigung h-profils - Vis a tete fraisée pour profil h - Vite per profilo ad h - Schroef ter bevestiging h-profiel - Kruvi H-profiilile 	1	4x60	
HS13	Screw for post - Schrauben für pfosten - Vis de fixation des poteaux - Viti per inviare - Schroef voor stijlen - Kruvi postile 	4	4x60	
HS18	Screw for wall details - Schraube für wand details - Vis pour mur details - Viti per elementi della porta - Schroef voor wand details - Kruvi seinadetailidele 	8	5x120	
HS18	Screw for gable - Schrauben für giebel - Vis pour fixation des pignons - Viti per timpano - Schroef voor gevelpunt - Kruvi viilude kinnitamiseks 	6	5x120	
HS20	Screw for post height adjustment - Schrauben für regulierungsschraube für pfosten - Vis de fixation de support réglable de poteau - Viti per fissare ed aggiustare l'altezza del palo verticale - Schroef voor hoogte instelling stijlen - Kruvi vajumispolidile 	16	6x50	
SH28	Hammer block - Schlagholz - Calle de frappe - Blocco di legno da usare come cuscinetto quando si usa il martello - Slagklos - Löögiklots 	1		
SFS	Nut for storm protection - Schraubenmutter für sturmleiste - Ecrou pour latte anti-tempete - Dado x asta protezione vento - Moer voor stromverankering - Mutter tormikinnitusliistule 	8	D6	
NF4	Zn nail for roof - Zn nagel für dachbretter - Pointe pour fixation voliges de toit - Chiodi x perline tetto - Spijker(nagel) voor dakhout - Nael katuselauale 	292	2x50	
NF5	Zn nail for roofing felt fillet - Zn nagel für dachpappenleiste - Pointe pour baguette de fixation feutre bitumeux - Chiodi x carta bituminosa x tetto - Spijker(nagel) voor asfaltpapier afdekljst - Papilistunael 	26	2x40	
BFS	Bolt for storm protection - Bolzen für sturmleiste - Boulon pour latte anti-tempete - Bullone x asta protezione vento - Bout voor stormankerlat - Puidupolt tormikinnitusliistule 	8	6x60	
DFS	Washer for storm protection - Dichtscheibe für sturmleiste - Rondelle pour latte anti-tempete - Rondella x asta protezione vento - Afdichtring voor storm strip - Seib tormikinnitusliistule 	8	D6	
BM	Beam holder - Balkenhalter - Support en u galvanisé - Supporto della trave Balkendrager (gording schoen) - Talaking 	12	45x137	
RP	Post height adjustment - Pfostenträger verstellbar - Support réglable de poteau - Piede registrabile in altezza - Stelschroef voor stijlpost - Vajumispollt 	2	D20	
	Door - Tür - Porte - Porte - Deur - Uks 1494x1850 TUK.4.020.SVP.MX28 SGA+28	1		

Pos	19.04.2018 Piece list - Stückliste - Liste des pièces - Elementi - Stuklijst - Tükitalabel 14.94x1850 TUK.4.020.SVP.MX28 SGA+28	1/2	Q	P (mm)	L (mm)
	<p>Glass size - Glasgröße - Taille de la vitre - Misura del vetro - Glas afmeting - Klaasi mõõt: 502x325 mm</p>   <p>1418x1792 mm</p>				
1	Upper door jamb - Türrahmen oben - Cadre de porte supérieur - Telaio superiore della porta - Bovendorpel - Ukse ülemine leng		1	66x100	1628
2	Left door jamb - Türrahmen links - Cadre de porte gauche - Telaio montante sinistro della porta - Linkerstijl deurframe - Ukse vasak leng		1	66x80	1850
3	Right door jamb - Türrahmen rechts - Cadre de porte droit - Telaio montante destro della porta - Rechterstijl deurframe - Ukse parem leng		1	66x80	1850
4	Doorstep - Swelle - Barre de seuil - Soglia della porta - Deurdorpel - Lävepak		1	18x18	1418
5	Connection strip - Deckleiste - Baguette de battement - Profilo verticale della porta - Stulplijst - kokkuvalltsiliist		1	13x32	1812





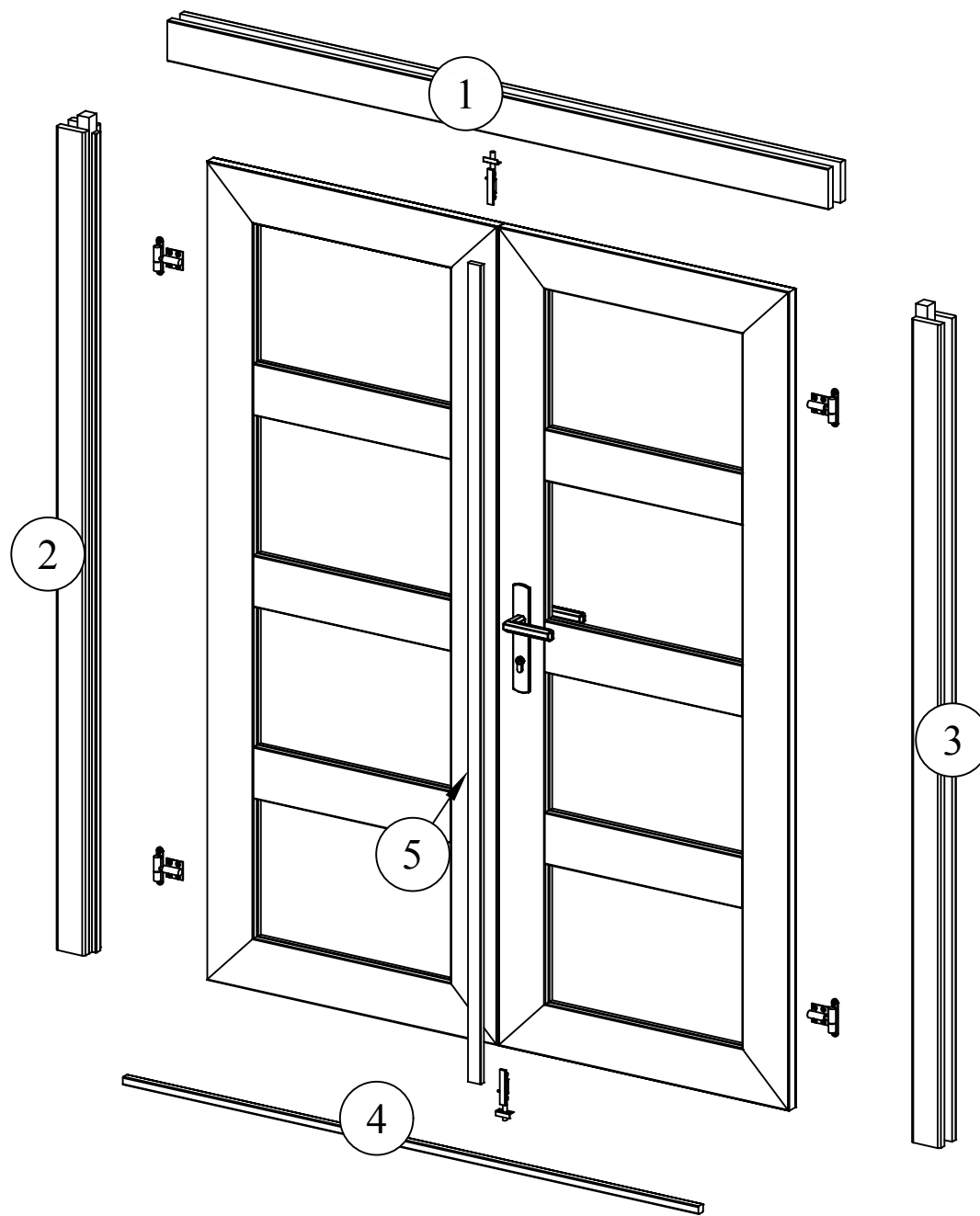

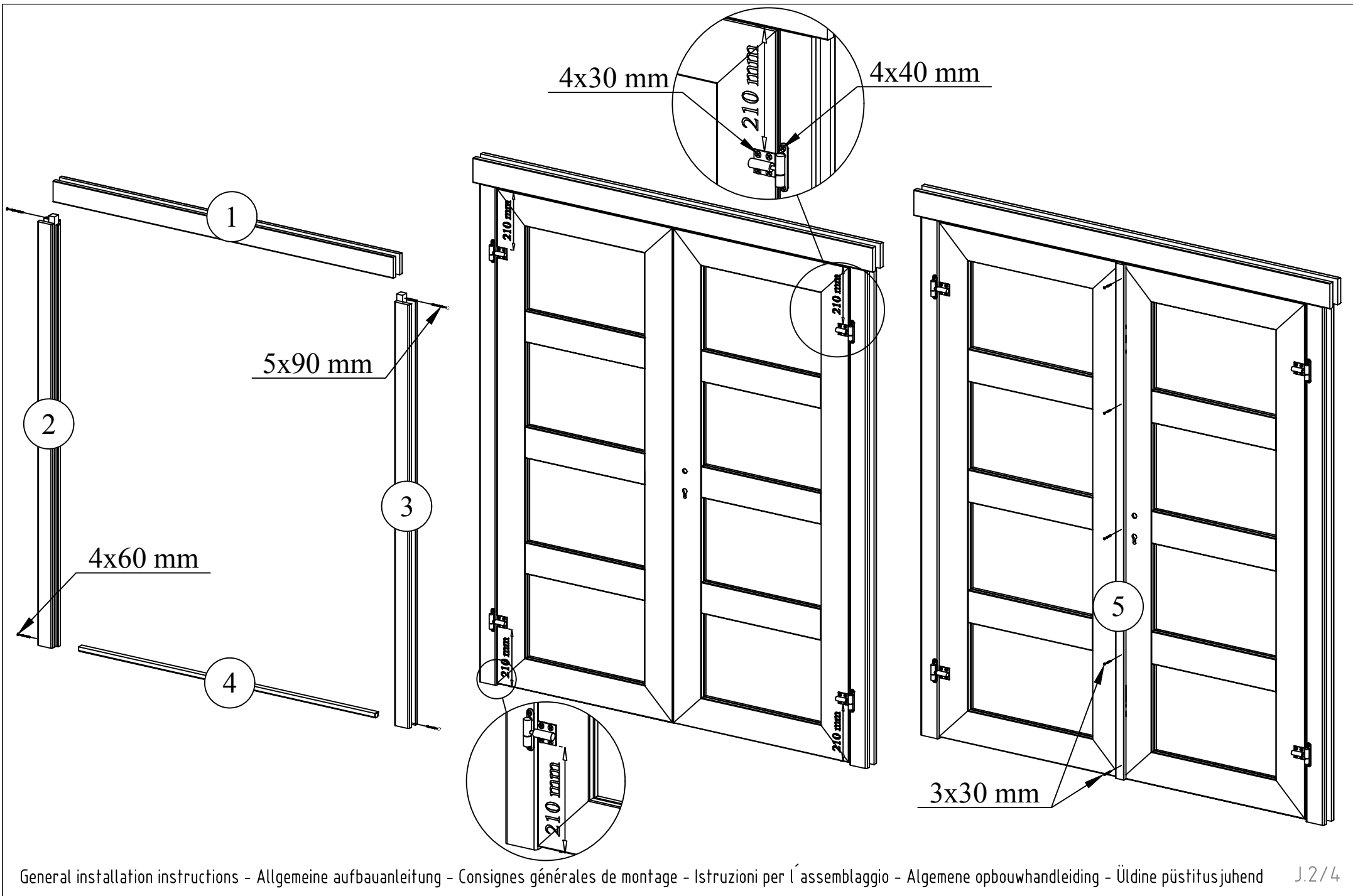

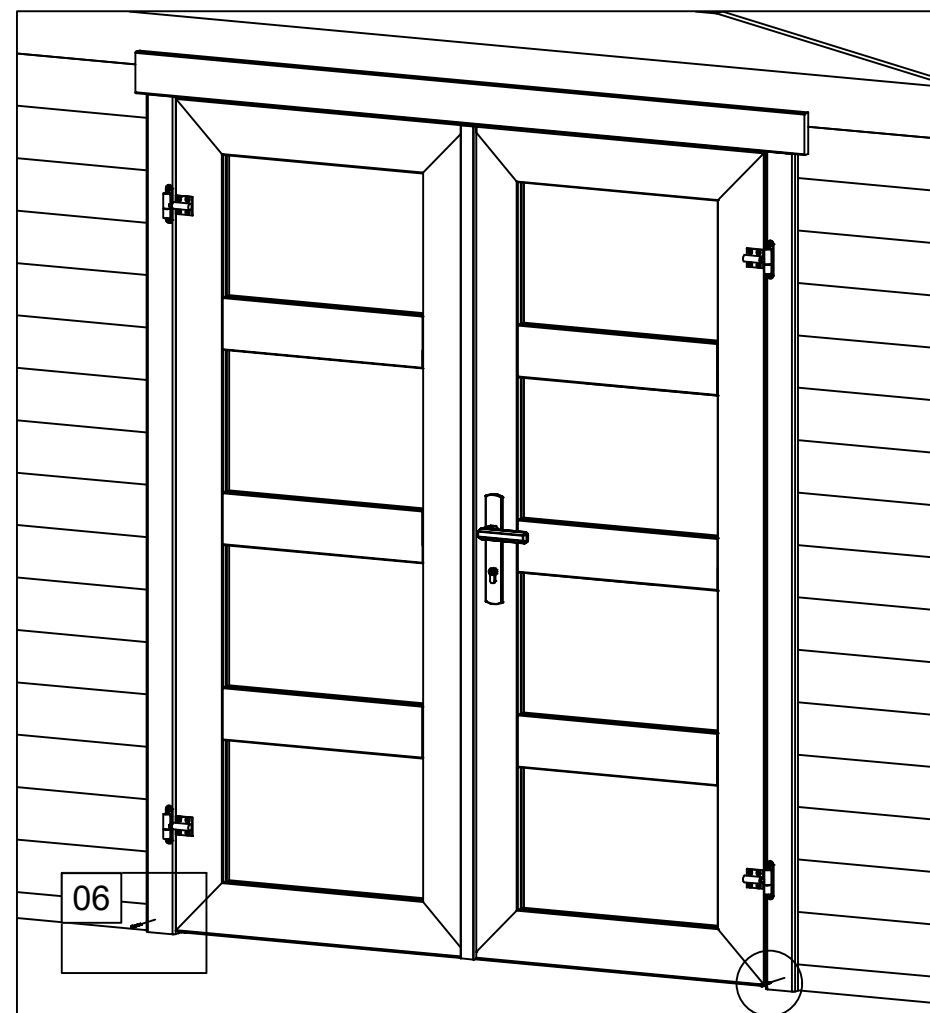
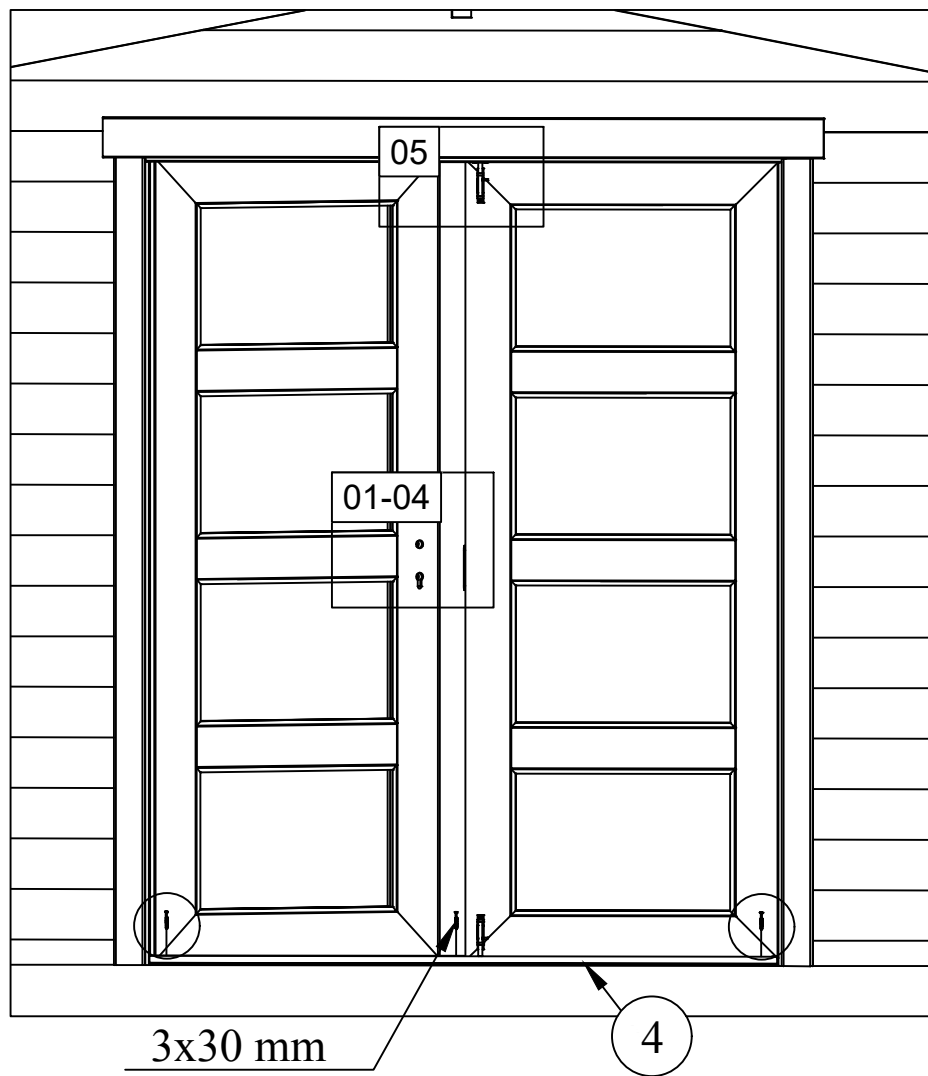

01

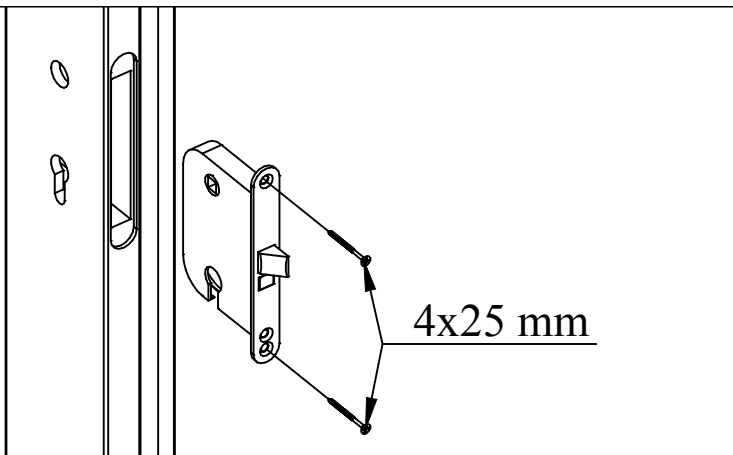

04

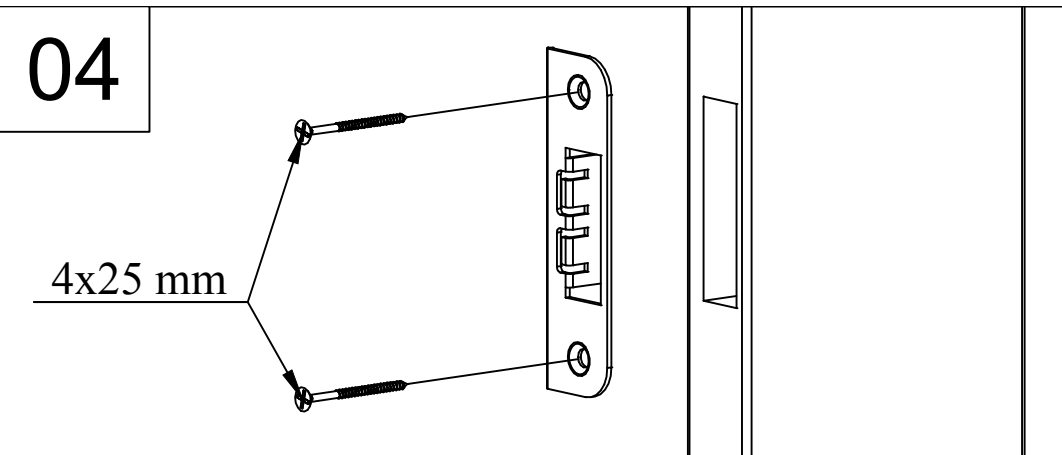

02



05



03



06

