

*Hawaii 70*  
*Art. Nr.7016594*

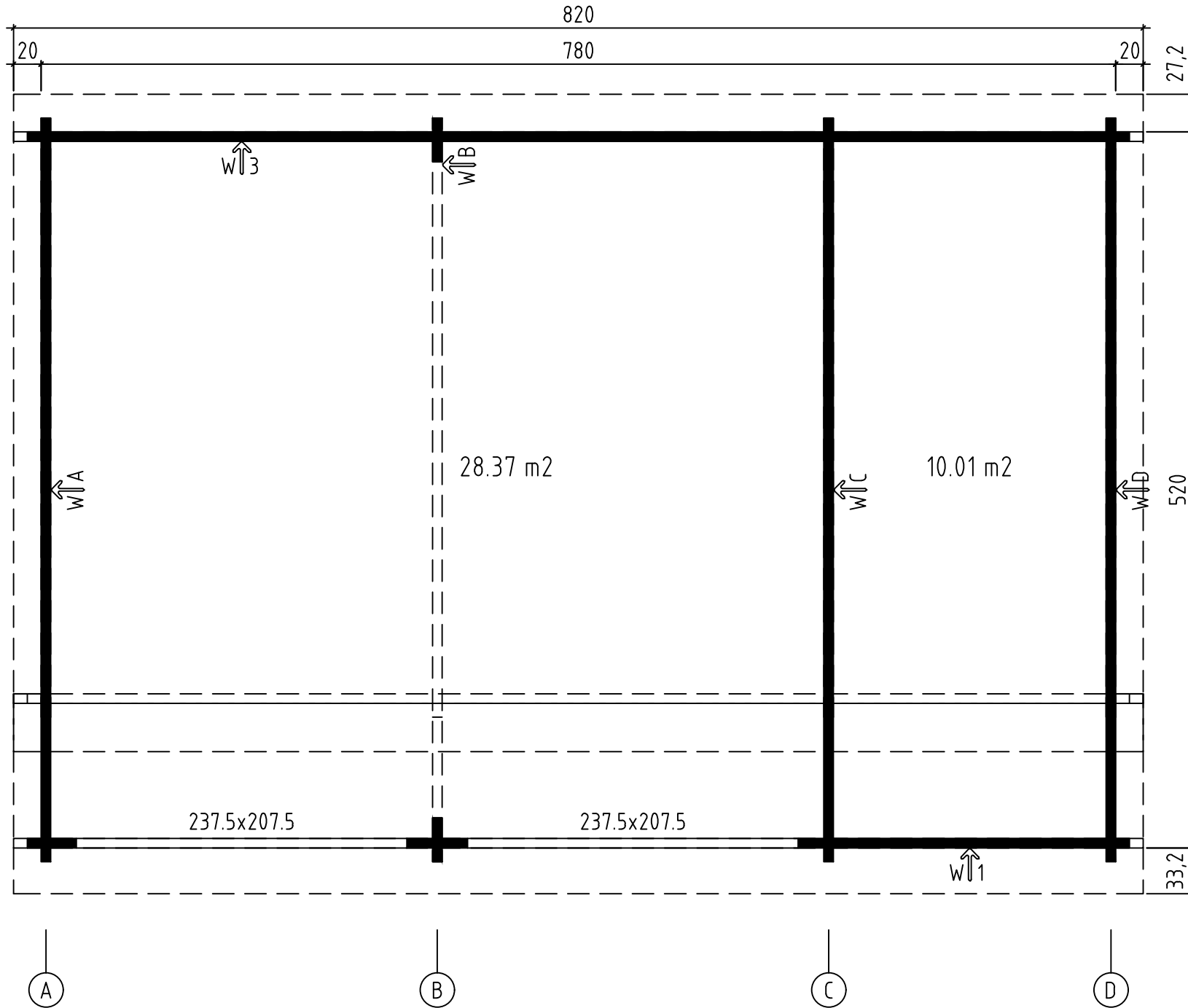

GROUNDPLAN - GRUNDPLAN - PLAN DE MASSE



# FOUNDATION - FUNDAMENT - FONDATION

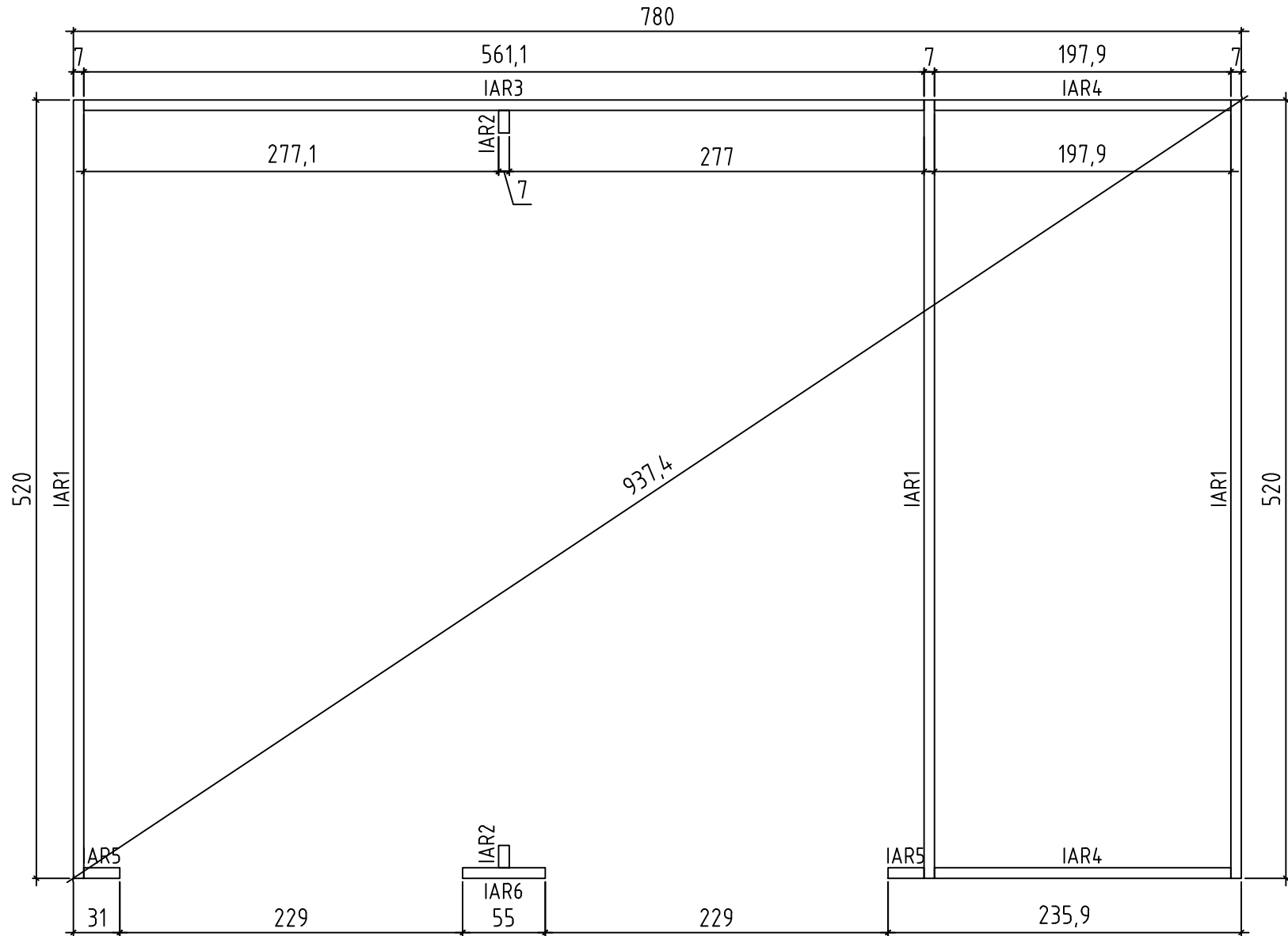

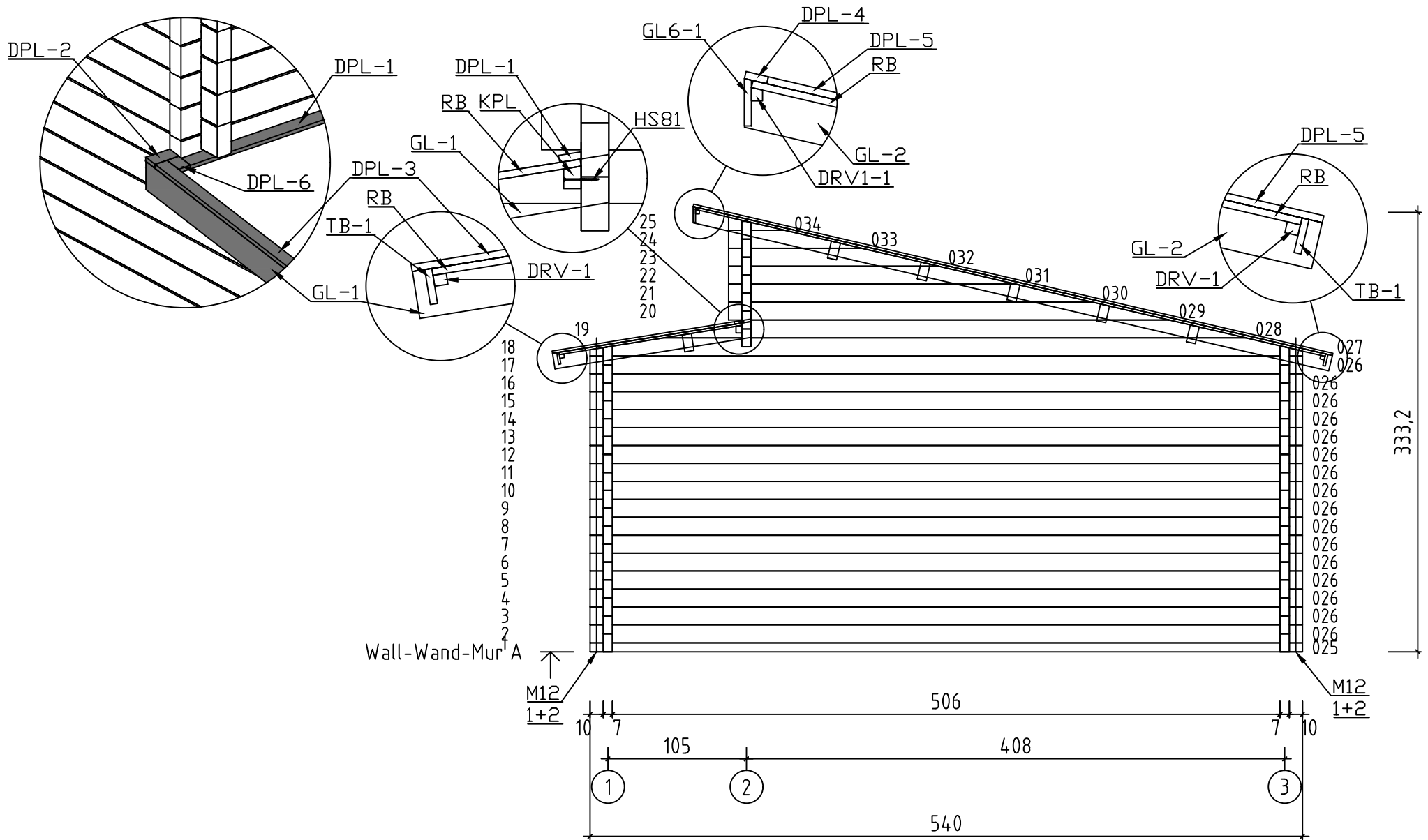

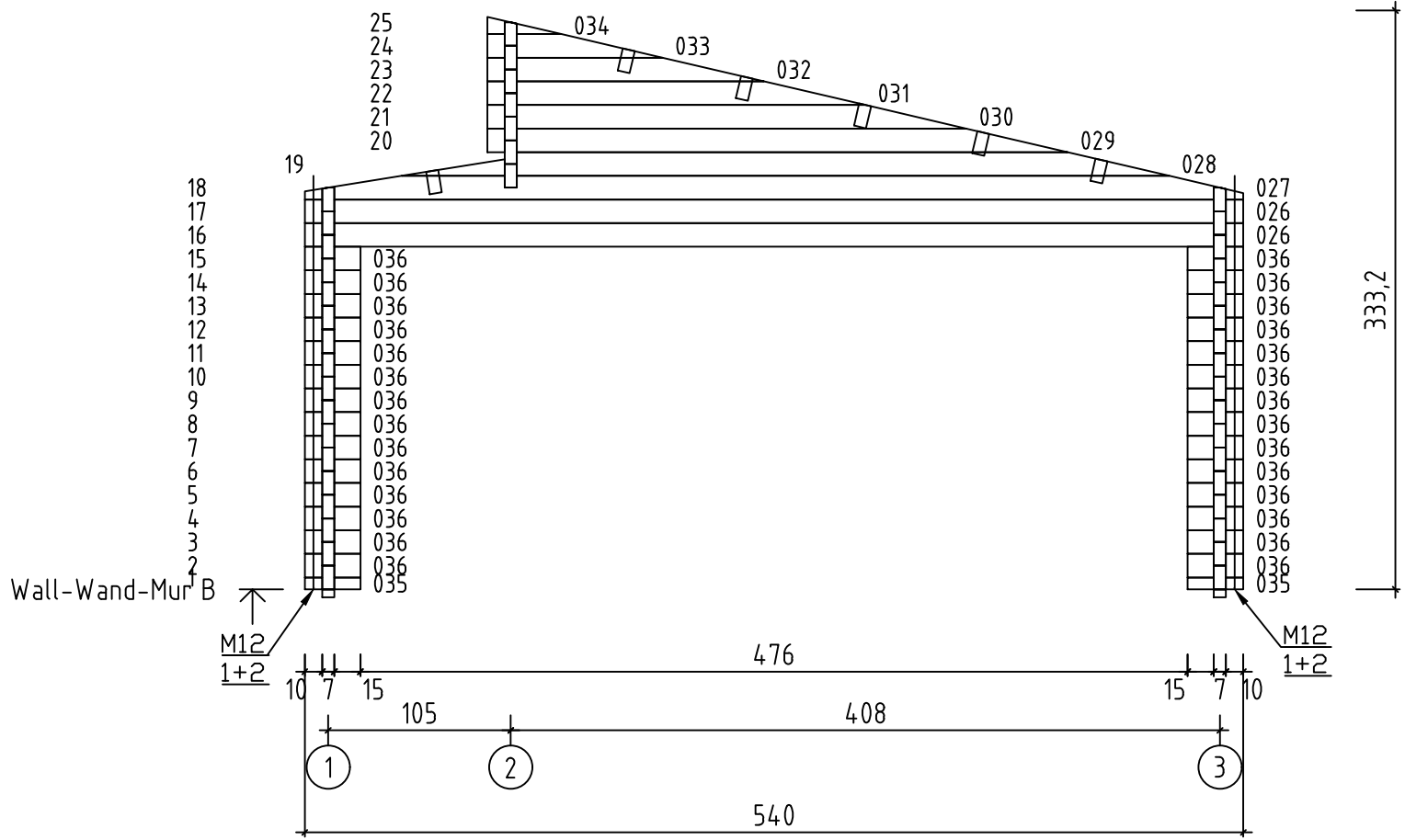









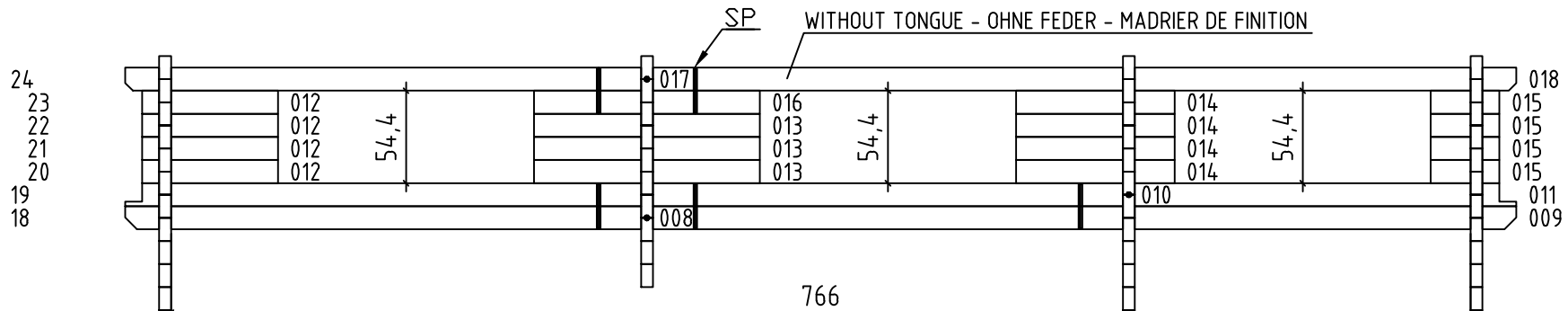



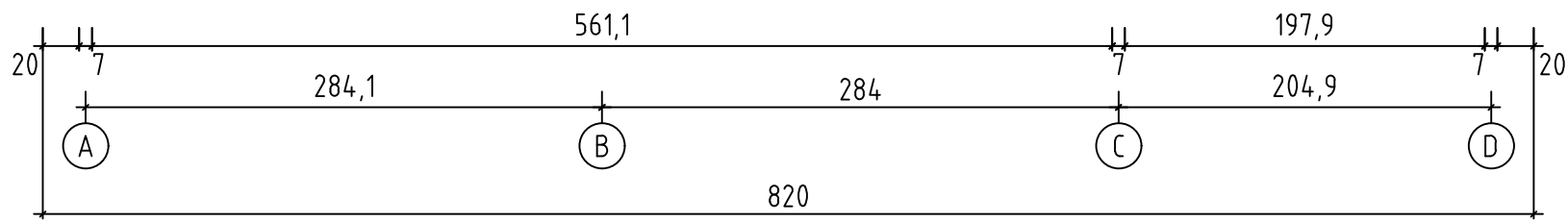





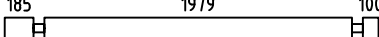
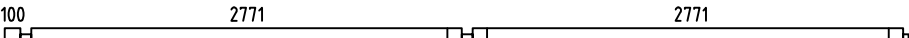
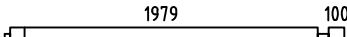
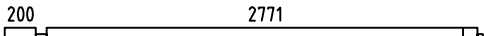
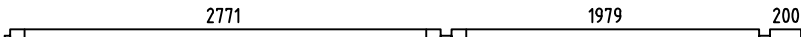
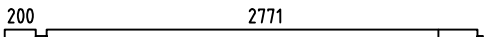
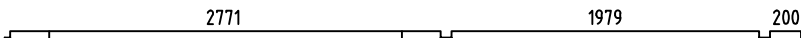

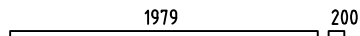
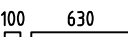

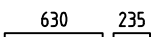

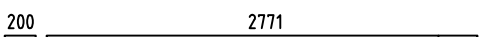

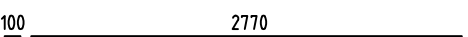

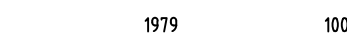
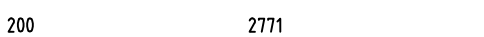

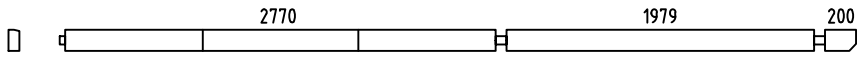
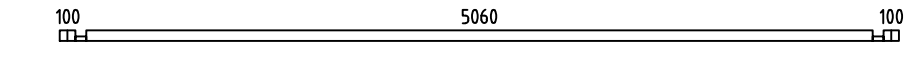
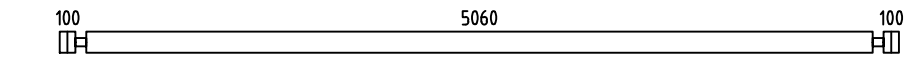
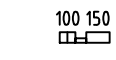

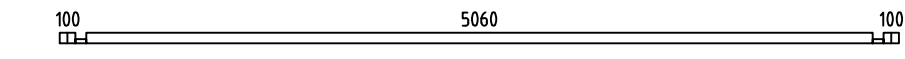
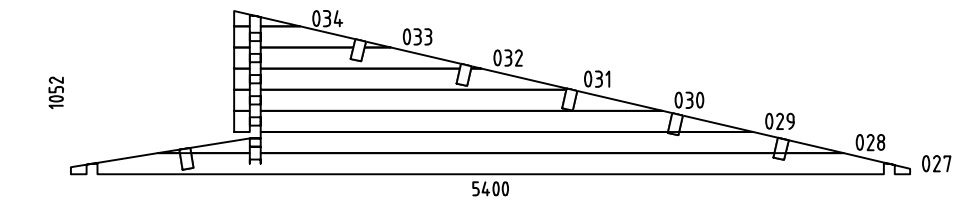
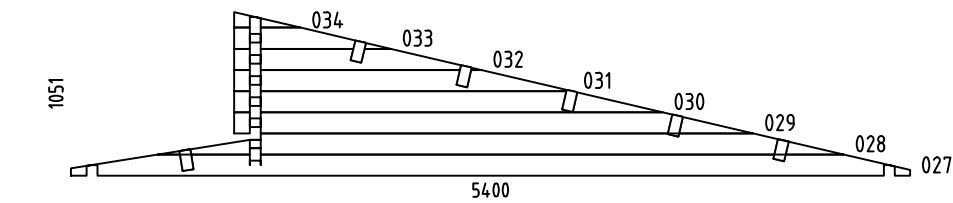
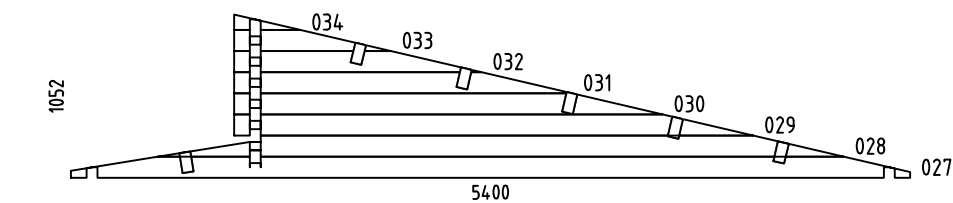
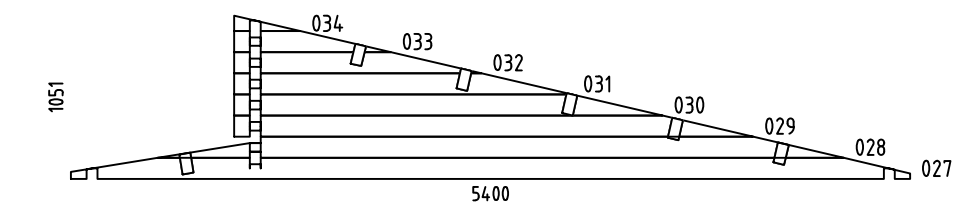
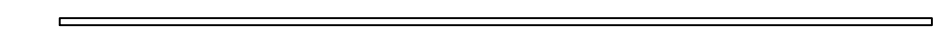
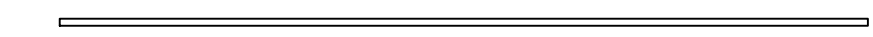
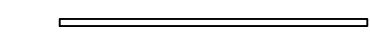
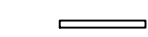



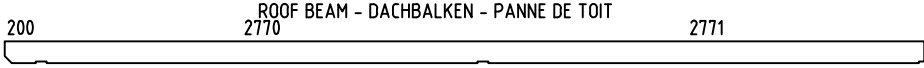
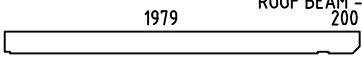





Wall-Wand-Mur 2 ↗

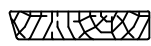
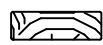

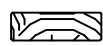



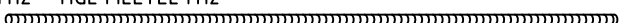
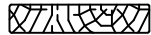

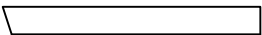
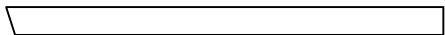





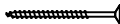
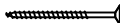
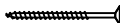
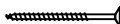
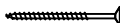
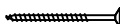



Pos	7016594 - Hawaii 70 Piece list - Stückliste - Liste des pièces	Q.	P (mm)	L (mm)
001	100 185 	15	70x136	355
002	185 185 	15	70x136	441
003	185 1979 100 	15	70x136	2404
004	100 2771 2771 	1	70x136	5816
005	1979 100 	1	70x136	2184
006	200 2771 	1	70x136	3076
007	2771 1979 200 	1	70x136	5125
008	200 2771 	1	70x136	3076
009	2771 1979 200 	1	70x136	5125
010	200 2771 2770 	1	70x136	5916
011	1979 200 	1	70x136	2284
012	100 630 	4	70x136	800
013	630 630 	3	70x136	1331
014	630 235 	4	70x136	935
015	234 100 	4	70x136	404
016	630 630 	1	70x136	1331
017	200 2771 	1	70x136	3076
018	2771 1979 200 	1	70x136	5125
019	100 2770 	8	70x136	2976
020	2771 1979 100 	8	70x136	5025
021	100 2770 2770 	8	70x136	5816
022	1979 100 	8	70x136	2184
023	200 2771 	1	70x136	3076

Pos	7016594 - Hawaii 70 Piece list - Stückliste - Liste des pièces	Q.	P (mm)	L (mm)
024		1	70x136	5125
025		1	70x68	5400
026		50	70x136	5400
035		2	70x68	320
036		28	70x136	320
037		2	70x68	5400
WA-1		1		
WB-1		1		
WC-1		1		
WD-1		1		
IAR3	FOUNDATION - FUNDAMENT - FONDATION 	1	70x45	5611
IAR1	FOUNDATION - FUNDAMENT - FONDATION 	3	70x45	5200
IAR4	FOUNDATION - FUNDAMENT - FONDATION 	2	70x45	1979
IAR6	FOUNDATION - FUNDAMENT - FONDATION 	1	70x45	550
IAR5	FOUNDATION - FUNDAMENT - FONDATION 	2	70x45	240

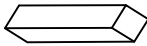
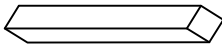
Pos	7016594 - Hawaii 70 Piece list - Stückliste - Liste des pièces	Q.	P (mm)	L (mm)
IAR2	FOUNDATION - FUNDAMENT - FONDATION 	2	70x45	150
A-PR1	ROOF BEAM - DACHBALKEN - PANNE DE TOIT 	6	70x140	5916
A-PR2	ROOF BEAM - DACHBALKEN - PANNE DE TOIT 	6	70x140	2284
RB-1	ROOF BOARDS - DACHBRETTER - VOLIGES 	92	90x18	4900
RB-2	ROOF BOARDS - DACHBRETTER - VOLIGES 	7	90x18	1471
RB-3	ROOF BOARDS - DACHBRETTER - VOLIGES 	85	90x18	1400
DPL-1	ROOFING FELT FILLET - DACHPAPPENLEISTE - BAGUETTE DE FIXATION DU FEUTRE BITUMEUX 	2	18x58	4000
KPL-1	WALL FINISHING BOARD - ABSCHLUSSBOHLE - MADRIER SUPÉRIEUR DE FINITION 	1	45x57	1978
KPL-2	WALL FINISHING BOARD - ABSCHLUSSBOHLE - MADRIER SUPÉRIEUR DE FINITION 	2	45x57	2000
KPL-3	WALL FINISHING BOARD - ABSCHLUSSBOHLE - MADRIER SUPÉRIEUR DE FINITION 	2	45x57	2770
DRV1-1	ROOF EDGE REINFORCEMENT - DACHRANDVERSTÄRKUNG - CORNIERE DE RENFORT DE BORD DE TOIT 	3	28x34	2733
GL6-1	GABLE MOULDING - GIEBELLEISTE - PLANCHE DE RIVE 	2	18x120	4100
DPL-6	ROOFING FELT FILLET - DACHPAPPENLEISTE - BAGUETTE DE FIXATION DU FEUTRE BITUMEUX 	2	18x58	75
DPL-2	ROOFING FELT FILLET - DACHPAPPENLEISTE - BAGUETTE DE FIXATION DU FEUTRE BITUMEUX 	2	18x58	118
DPL-3	ROOFING FELT FILLET - DACHPAPPENLEISTE - BAGUETTE DE FIXATION DU FEUTRE BITUMEUX 	2	18x58	1470
DPL-4	ROOFING FELT FILLET - DACHPAPPENLEISTE - BAGUETTE DE FIXATION DU FEUTRE BITUMEUX 	2	18x58	4118
DPL-5	ROOFING FELT FILLET - DACHPAPPENLEISTE - BAGUETTE DE FIXATION DU FEUTRE BITUMEUX 	2	18x58	4917
M12-1	TREADED ROD M12 - GEWINDESTANGE M12 - TIGE FILETÉE M12 	8		330
M12-2	TREADED ROD M12 - GEWINDESTANGE M12 - TIGE FILETÉE M12 	8		2000
TB-1	EAVES BOARD - TRAUFBRETT - BANDEAU DE TOIT 	4	18x90	4100
DRV-1	ROOF EDGE REINFORCEMENT - DACHRANDVERSTÄRKUNG - CORNIERE DE RENFORT DE BORD DE TOIT 	6	28x34	2733
GL-1	GABLE MOULDING - GIEBELLEISTE - PLANCHE DE RIVE 	2	18x120	1524
GL-2	GABLE MOULDING - GIEBELLEISTE - PLANCHE DE RIVE 	2	18x120	4975

Pos	7016594 - Hawaii 70 Piece list - Stückliste - Liste des pièces	Q.	P (mm)	L (mm)
KL4	LENGTHENING BOLT FOR TREADED ROD - VERLÄNGERUNGSMUTTER FÜR GEWINDESTANGE - MANCHON DE RACCORDEMENT DE TIGE FILETÉE		8	
KL1	DRIVE NUT TREADED ROD - EINSHLAGMUTTER FÜR GEWINDESTANGE - ÉCROU A FRAPPER POUR TIGE FILITÉE		8	
KL2	NUT FOR TREADED ROD - MUTTER FÜR GEWINDESTANGE - ÉCROU POUR TIGE FILETÉE		8	
KL3	PLAIN WASHER TREADED ROD - UNTERLEGSSCHEIBE FÜR GEWINDESTANGE - RONDELLE PLATE POUR TIGE FILETÉE		8	
HS16	SCREW FOR GABLE MOULDING - SCHRAUBEN FÜR GIEBELLEISTE - VIS DE FIXATION POUR PLANCHE DE RIVE		66	3.5x50
HS32	SCREW FOR EAVES BOARDS - SCHRAUBEN FÜR TRAUFBRETTEN - VIS DE FIXATION POUR BANDEAU DE TOIT		54	4x40
HS26	SCREW FOR ROOF EDGE REINFORCEMENT - SCHRAUBEN FÜR DACHRANDVERSTÄRKUNG - VIS POUR RENFORT DE BORD DE TOIT		54	4x40
HS39	SCREW FOR FUNDAMENT - SCHRAUBEN ZUR BEFESTIGUNG FUNDAMENT - VIS POUR FONDATION		10	5x120
HS42	SCREW FOR GABLE - SCHRAUBEN FÜR GIEBEL - VIS POUR FIXATION DES PIGNONS		48	5x120
HS39	SCREW FOR FUNDAMENT - SCHRAUBEN ZUR BEFESTIGUNG FUNDAMENT - VIS POUR FONDATION		14	5x90
HS81	SCREW FOR ROOF EDGE REINFORCEMENT - SCHRAUBEN FÜR DACHRANDVERSTÄRKUNG - VIS POUR FIXATION CORNIERE RENFORT DE BORD DE TOIT		23	5x90
HS40	SCREW FOR 1. WALL BEAM - SCHRAUBE FÜR 1. BOHLENREIHE - VIS DE FIXATION DES FONDATIONS		14	6x150
HS48	SCREW FOR GABLE - SCHRAUBEN FÜR GIEBEL - VIS POUR FIXATION DES PIGNONS		17	6x180
HS44	SCREW FOR RAFTER - SCHRAUBEN ZUR BEFESTIGUNG DACHSPARREN - VIS POUR CHEVRON		18	6x180
HS51	SCREW FOR BEAM HOLDER - SCHRAUBEN FÜR BALKENHALTER - VIS DE FIXATION SUPPORT U GALVANISÉ		12	4.5x35
SH70	HAMMER BLOCK - SCHLAGHOLZ - CALLE DE FRAPPE		2	
NFD	ZN NAIL FOR ROOFING FELT FILLET - ZN NÄGEL FÜR DACHPAPPENLEISTE - POINTE POUR BAGUETTE FIXATION FEUTRE BITUMEUX		70	2x40
NF2	ZN NAIL FOR ROOF - ZN NÄGEL FÜR DACHBRETTEN - POINTE POUR TOIT		950	2x50
ORZ	MONTAGE SET FOR DOORS AND WINDOWS - MONTAGE-SET FÜR TÜREN UND FENSTER - JEU DE MONTAGE PORTES ET FENETRES		1	
SP2	HIDDEN FIXING - HOLZDÜBEL - TOURILLON BOIS		2	
SP1	HIDDEN FIXING - HOLZDÜBEL - TOURILLON BOIS		25	
BHV	BEAM HOLDER - BALKENHALTER - SUPPORT EN U GALVANISÉ		12	

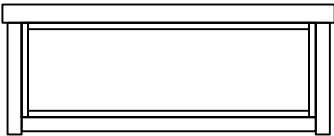
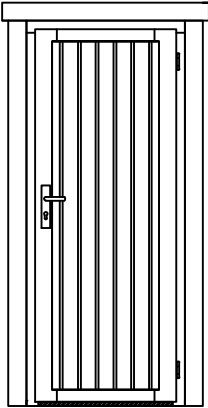
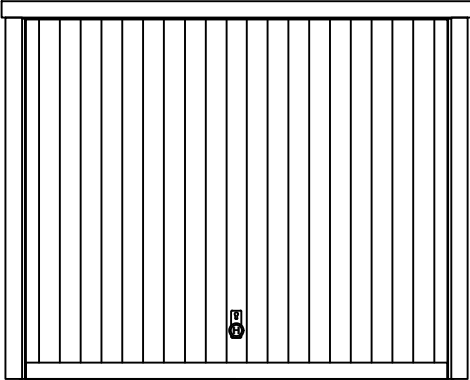
Pos	7016594 - Hawaii 70 Piece list - Stückliste - Liste des pièces	Q.	P (mm)	L (mm)
2+ A.0M	<p data-bbox="563 159 957 188">WINDOW - FENSTER - FENETRE 1500x510</p> 	3		
2+ U.2LP	<p data-bbox="608 434 911 463">DOOR - TÜR - PORTE 827x1933</p> 	1		
	<p data-bbox="600 974 919 1025">DOOR - TÜR - PORTE 2375x2075 Hörmann Berry</p> 	2		