

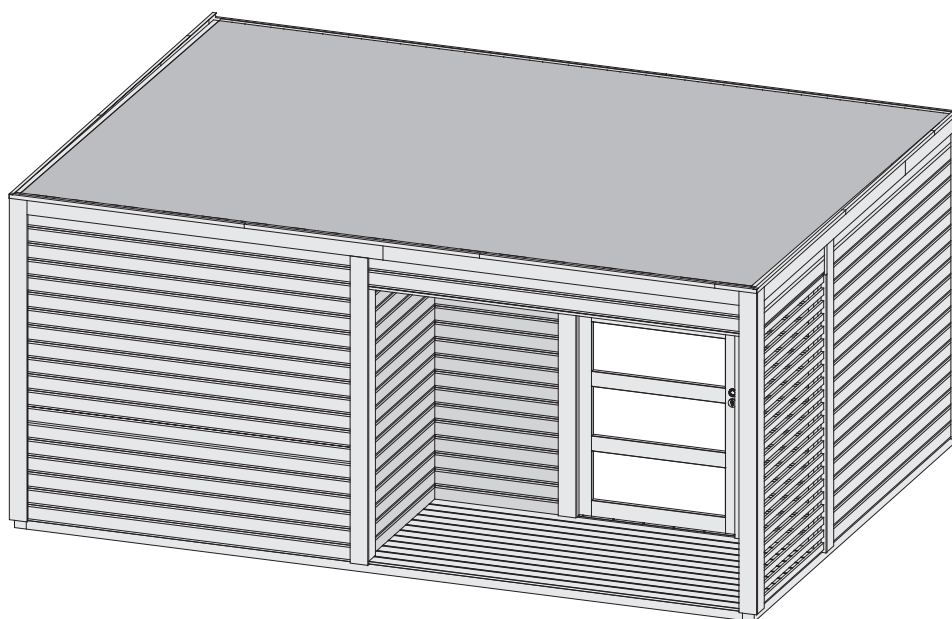

31619 31620

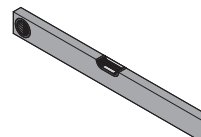

-  **Aufbauanleitung**
-  **Building Instructions**
-  **notice de montage**
-  **montagehandleiding**
-  **Montagevejledning**
-  **Instrucciones de construcción**
-  **Istruzioni per il montaggio**
-  **Montážní návod**

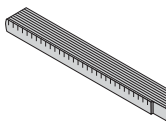
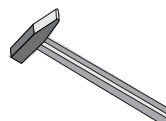
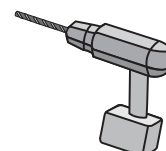
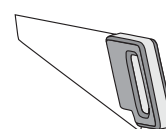





 Bitte bewahren Sie die Anleitung und den Garantieschein zur Seriennummer auf. Vernichten Sie diese erst nach Ablauf der Garantiezeit. Eventuelle Beanstandungen können mithilfe der Stückliste einfacher zugeordnet werden.

Beigelegte Dokumente:

- Informationsheft
- Garantieschein zur Seriennummer
- Typenschild inkl. Warnhinweise (Sauna)
- ggf. Zubehör-Anleitungen in externen Paketen

- *  Nicht im Lieferumfang enthalten
 Not included
 Non comprises dans la livraison
 Niet bijgeleverd



-  No forman parte del suministro
 Non incluso
 V ceně není zahrnuto
 Ikke inkluderet

- 1  Länge muss ermittelt und zugesägt werden
 Length must be determined and sawn
 La longueur doit être déterminée et sciée
 De lengte moet worden bepaald en worden gezaagd

-  La longitud debe ser determinada y aserrada
 La lunghezza deve essere determinata e segata
 Délka musí být určena a rozřezána
 Længden skal bestemmes og saves



- 2  Nicht gebraucht
 Not needed
 Pas nécessaire
 Niet nodig





-  No es necesario
 Non necessario
 Není nutná

- 3  mit Zubehör!
 met toebehoren!
 with accessories!
 avec accessoires!

-  con accesorios!
 con accessori!
 s příslušenstvím!
 z dodatki!



- 4  Fixiert vorübergehend
 tijdelijk vast
 Fixed temporarily
 temporairement fixe

-  temporalmente fijo
 temporaneamente fisso
 dočasně pevný
 Zčasno pritrjeno

- 5  Bestand vom Haus
 Inventaris van het huis
 Inventory of the house
 Inventaire de la maison

-  Inventario de la casa
 Inventario della casa
 Inventář domu
 Inventar hiše

Werkzeuge / Tools*

X

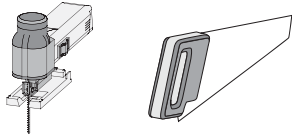

X



X



X



X



X

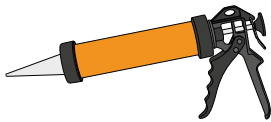

X

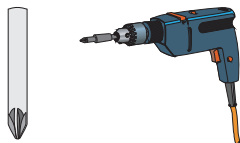

X

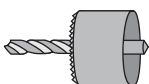
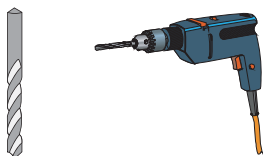

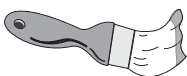

X





X





 Vergleichen Sie zuerst die Material-liste mit Ihrem Paketinhalt! Bitte haben Sie Verständnis, dass Beanstandungen nur im nicht aufgebauten Zustand bearbeitet werden können!

 Vergelijk eerst de lijst van materialen met de inhoud van uw pakket! Reclamaties kunnen alleen in behandeling worden genomen zolang de onderdelen nog niet zijn gemonteerd!

 Confrontate questa distinta materiali prima con il contenuto del pacchetto! Vi preghiamo di comprendere che eventuali reclami possono essere accolti solo prima del montaggio!

 First compare the list of materials with your package contents! Please understand that complaints can be processed in the non-built status only!

 Start med at kontrollere materialelisten med indholdet af den leverede pakke! Vi gør venligst opmærksom på at reklamationer kun kan behandles for materialer som ikke er blevet bearbejdet!

 Nejprve překontrolujte obsah balení podle materiálového listu! Mějte pochopení pro to, že případnou reklamaci se můžeme zabývat pouze tehdy, když díly nebudou smontované! Za pomoci tohoto seznamu můžete jednotlivé díly přiřadit k montážnímu návodu.

 Commencez par comparer la liste du matériel avec le contenu de votre paquet! Sachez que nous traitons uniquement les réclamations concernant le matériel à l'état non monté!

 En primer lugar, compare la lista de material con el contenido del paquete. Rogamos entienda que las reclamaciones sólo pueden ser tramitadas antes de montar el objeto!

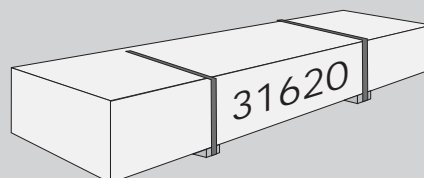
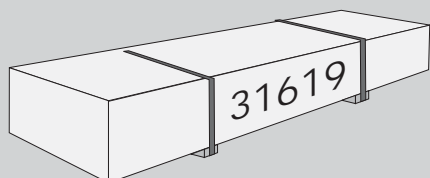

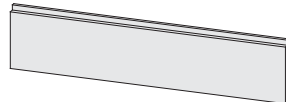
		
30 x U1	2321 x 96 x 19 mm	ID 31163
84 x U2	3570 x 96 x 19 mm	ID 31162

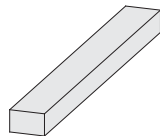
		
1 x B1 ^{kdi}	1081 x 20 x 15 mm	ID 17052
1 x B2	1081 x 36 x 18 mm	ID 17056
1 x B2 ^{kdi}	1810 x 36 x 18 mm	ID 17054
22 x B3	1110 x 45 x 18 mm	ID 56956
2 x B4	2540 x 45 x 18 mm	ID 16359
12 x B5 ^{kdi}	2633 x 95 x 18 mm	ID 31164
19 x B6	2520 x 120 x 18 mm	ID 80895
9 x B7	2294 x 140 x 26 mm	ID 31158
10 x B8	2587 x 140 x 26 mm	ID 31159
2 x B9	3600 x 140 x 26 mm	ID 12352
2 x B10	1830 x 58 x 28 mm	ID 31622
1 x B11	2000 x 38 x 38 mm	ID 23731
2 x B12	1854 x 58 x 38 mm	ID 79823
1 x B13	2000 x 78 x 38 mm	ID 81113
16 x B14	230 x 45 x 45 mm	ID 87208
12 x B15	2560 x 45 x 45 mm	ID 84955
4 x B16 ^{kdi}	3635 x 80 x 60 mm	ID 31150
5 x B17 ^{kdi}	4871 x 80 x 60 mm	ID 31149

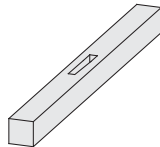
		
1 x B18	1910 x 45 x 45 mm	ID 31611

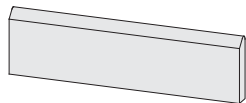
		
3 x H1	2000 x 58 x 17 mm	ID 48545

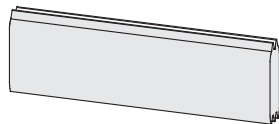
		
17 x W1	507 x 121 x 40 mm	ID 31616
17 x W2	908 x 121 x 40 mm	ID 31617
18 x W3	1295 x 121 x 40 mm	ID 31155
34 x W4	2320 x 121 x 40 mm	ID 31156
3 x W5	2610 x 121 x 40 mm	ID 31157
22 x W6	3570 x 121 x 40 mm	ID 67847
23 x W7	4970 x 121 x 40 mm	ID 67158

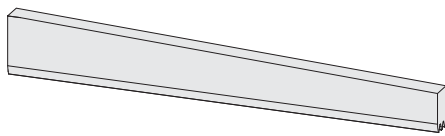
		
1 x G1	3570 x 78 x 40 mm	ID 31618
1 x G2	3570 x 96 x 40 mm	ID 31612
1 x G3	3570 x 96 x 40 mm	ID 31613

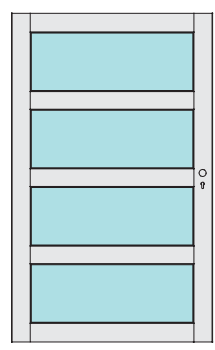
		
1 x K1	1833 x 1120 x 36 mm	ID 16806

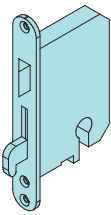
		
1 x K3		ID 16809

		
1 x K4		ID 19054

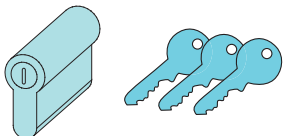
		
1 x K5		ID 19053

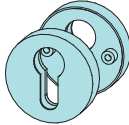
		
2 x K6		ID 19055

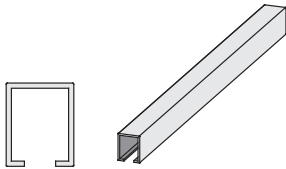
		
1 x Y1		ID 31608

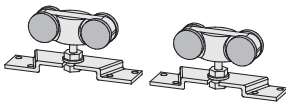
		
1 x Y2		ID 80334

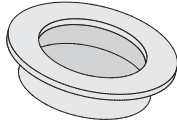
		
2 x Y3		ID 86725

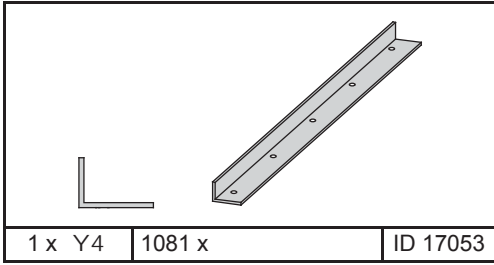

1 x Y4	1081 x	ID 17053
--------	--------	----------

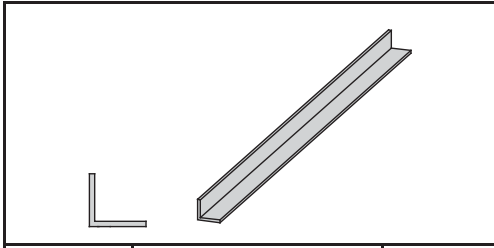

8 x Y5	1600 x	ID 61695
--------	--------	----------

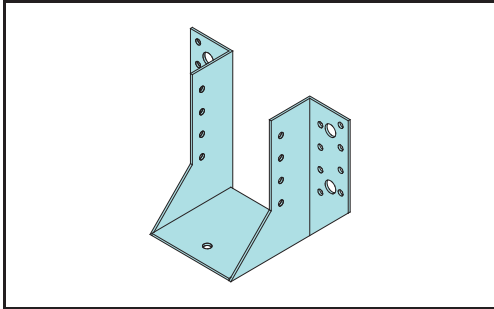

12 x Y6		ID 33143
---------	--	----------

200 x	4 x 35 mm	ID 3687
260 x	4 x 50 mm	ID 3688
20 x	4 x 60 mm	ID 21207
360 x	4 x 70 mm	ID 3689
515 x	4,5 x 80 mm	ID 9204
15 x	6 x 100 mm	ID 11749
40 x	6 x 120 mm	ID 9205

1 x	4 x 35 mm	ID 80355

45 x	4 x 40 mm	ID 36178

1200 x		ID 5621

 Übersicht
 Overview
 enquête

 overzicht
 undersøgelse
 estudio

 sondaggio
 přehled

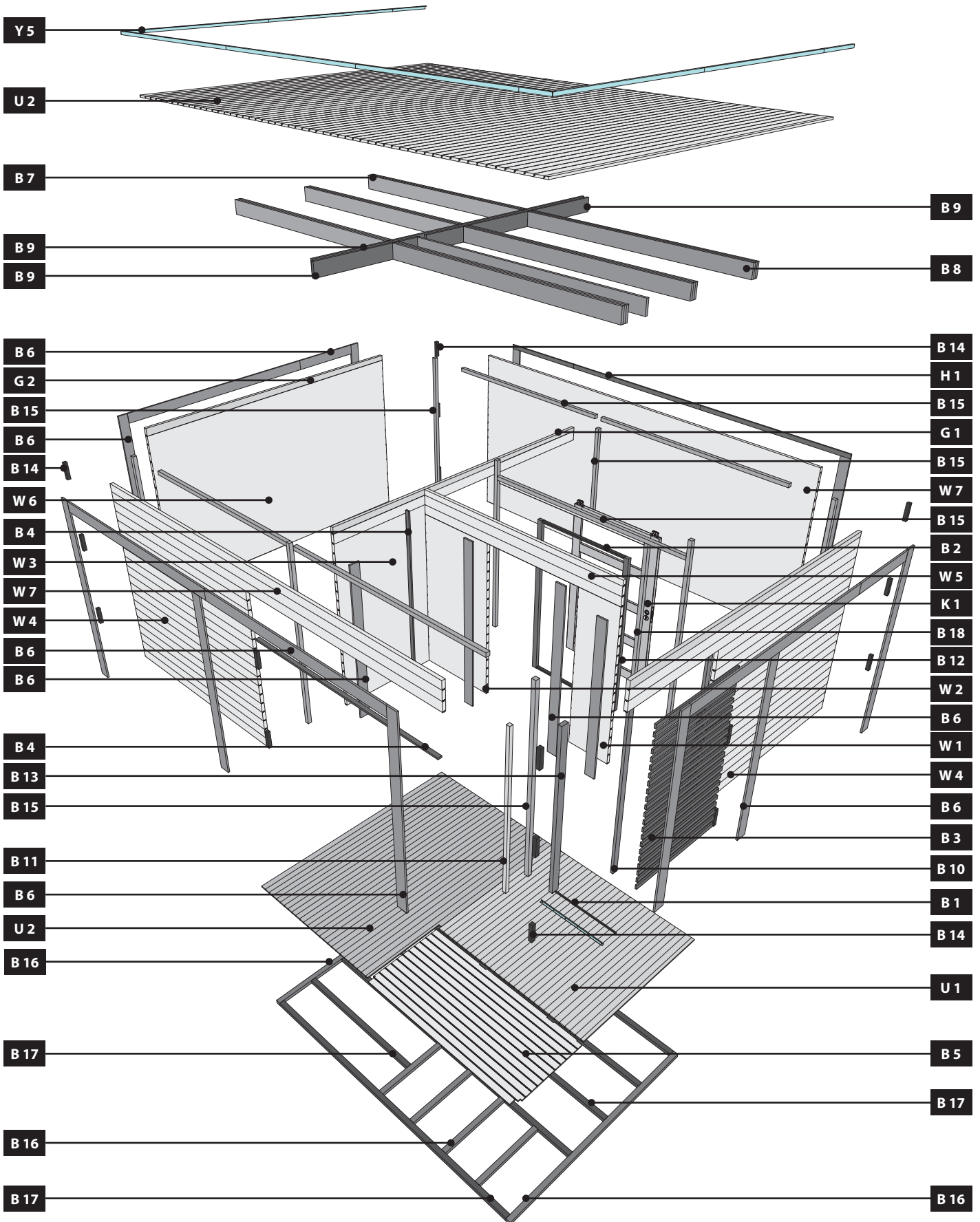

01

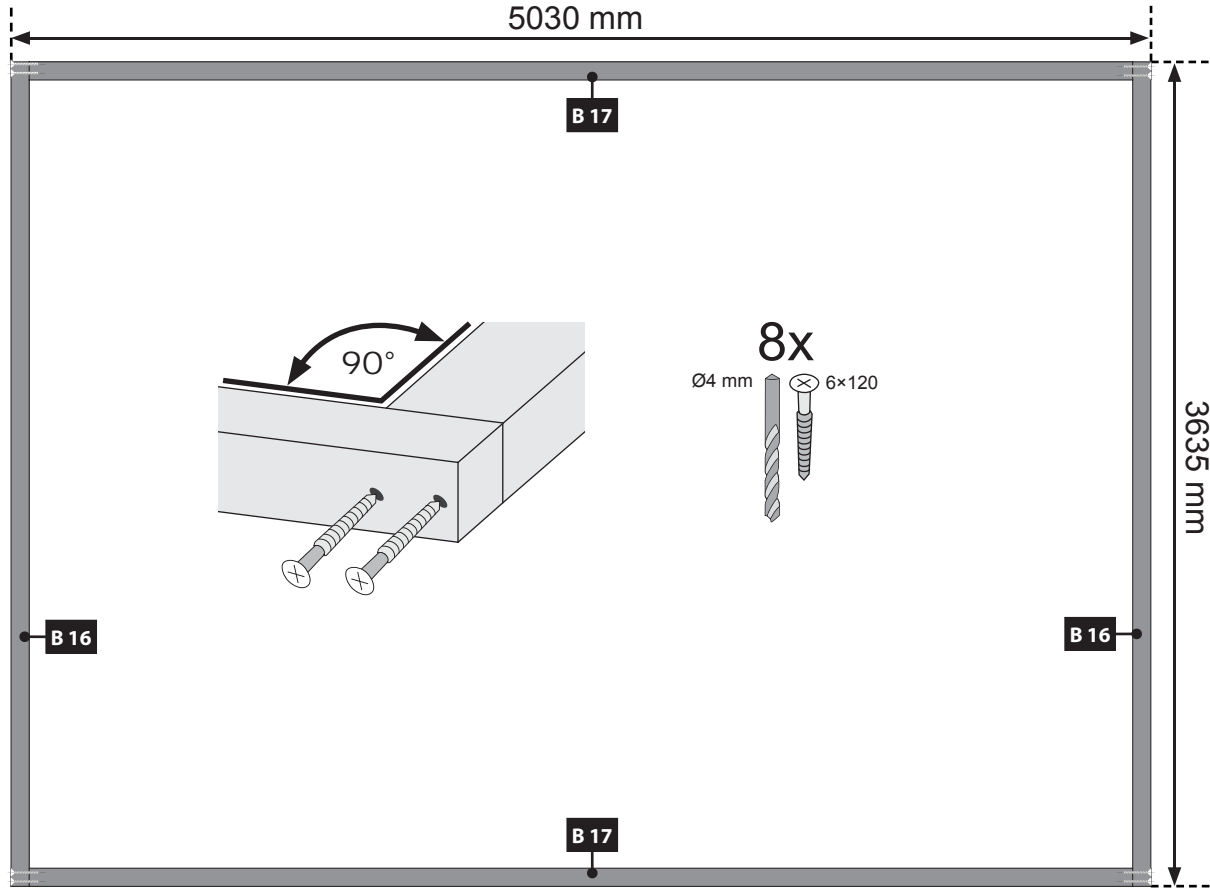
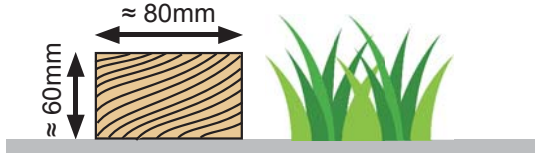

02

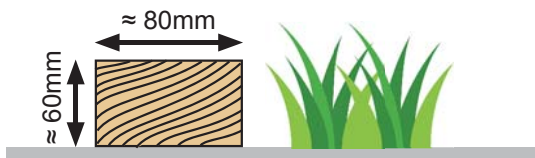

Ø4 mm 6x120
12x

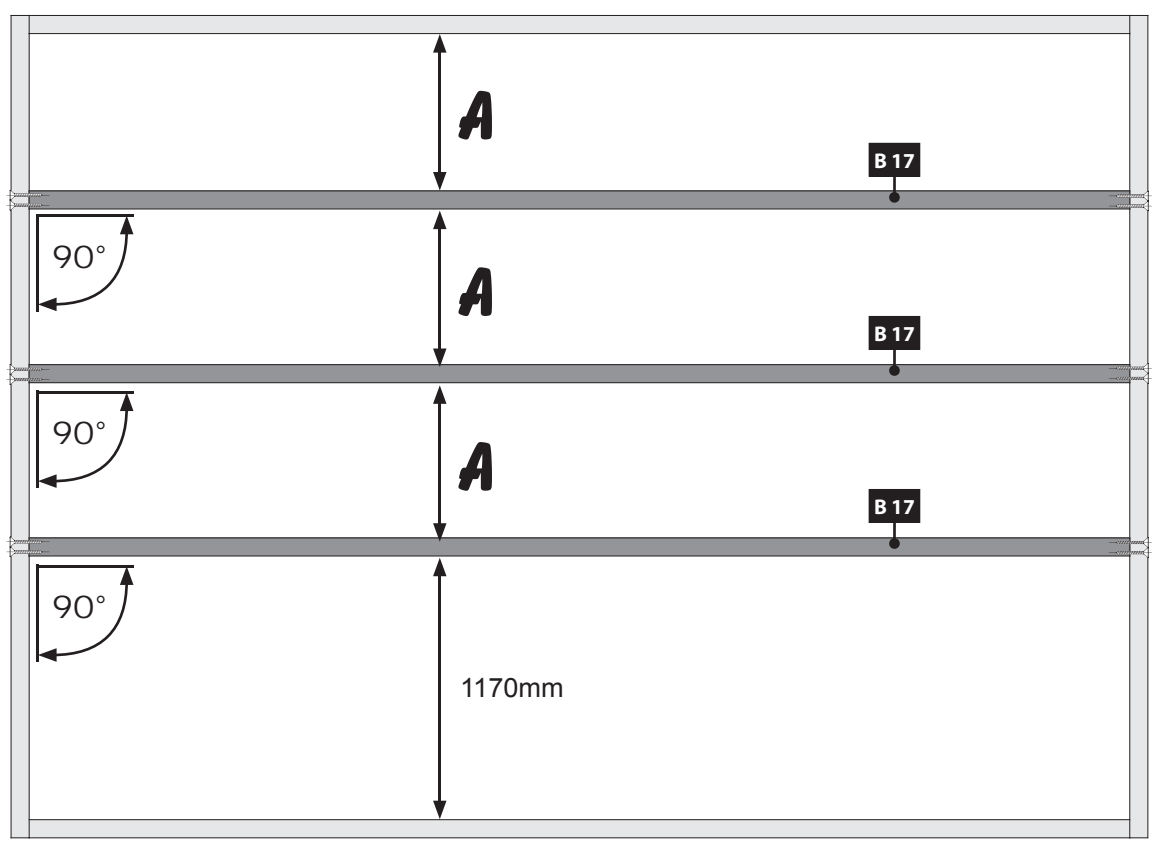

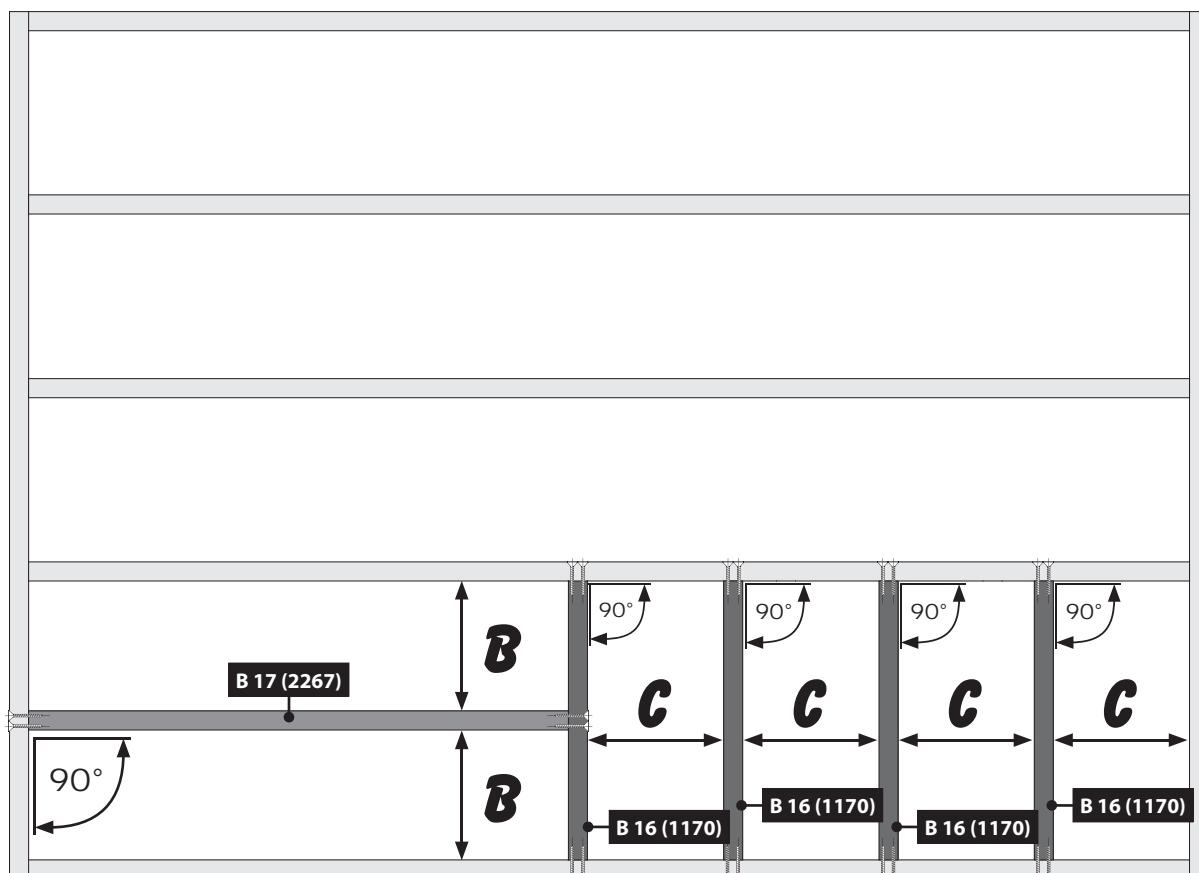
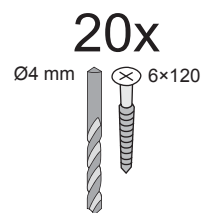
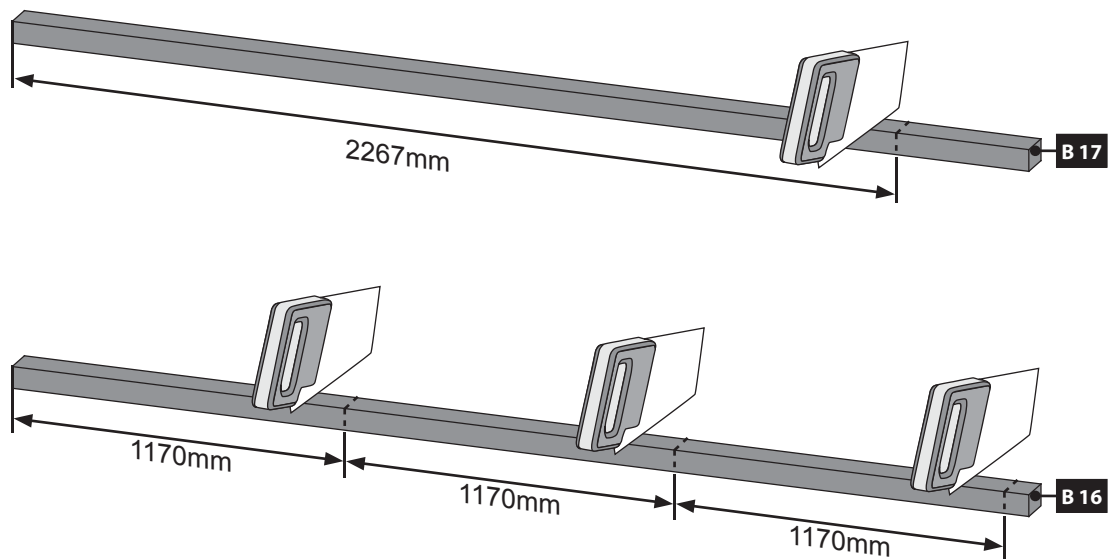



10x

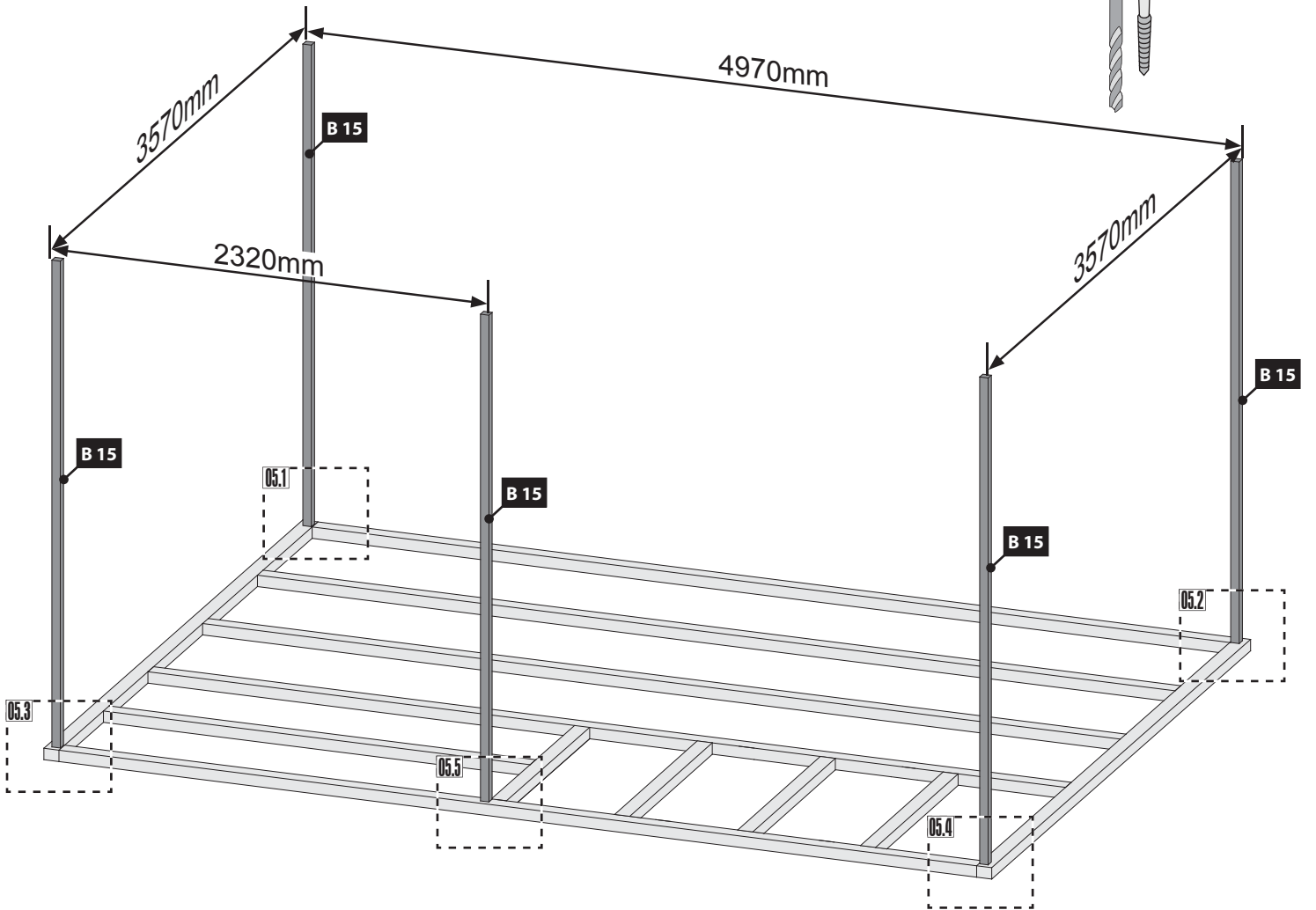
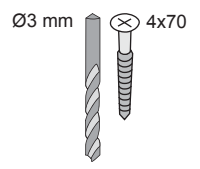

05.1

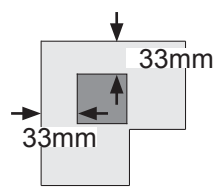
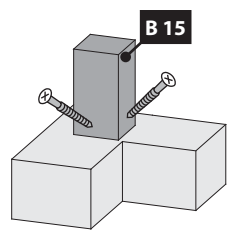

05.2

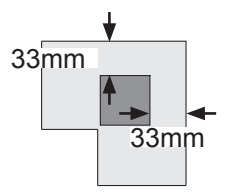
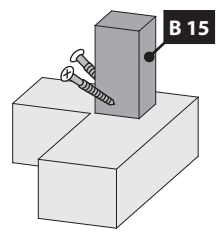

05.3

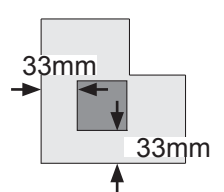
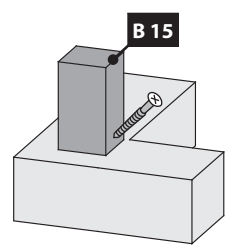



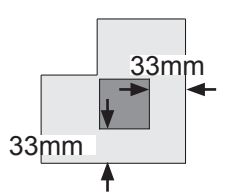
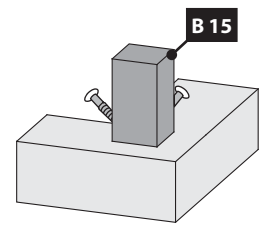

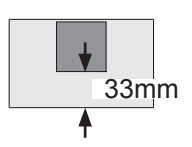
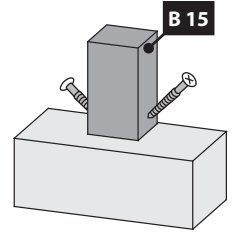

05.4





05.5



 Leim! Achten Sie auf die gleiche Höhe
 Glue! Look for the same height
 Colle! Faites attention à la même hauteur

 Lijm! Besteed aandacht aan de dezelfde hoogte
 Lim! Vær opmærksom på samme højde
 Pegamento! Prestar atención a la misma altura

 Colla! Prestare attenzione alla stessa altezza
 Klíh! Dávejte pozor na stejnou výšku

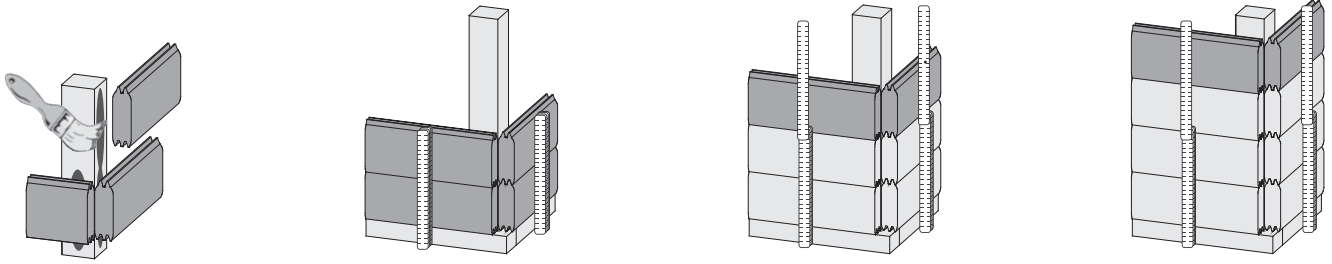

06

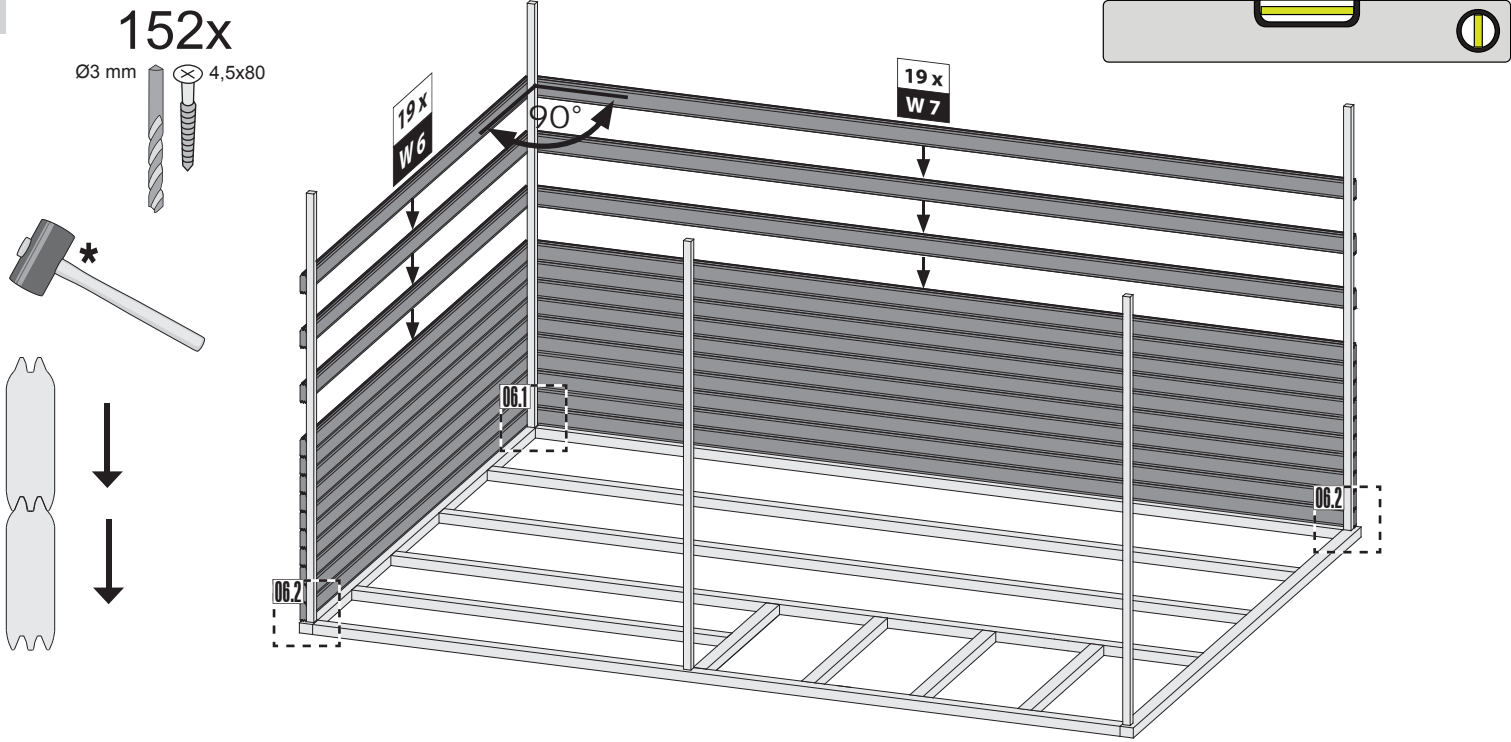

06.1

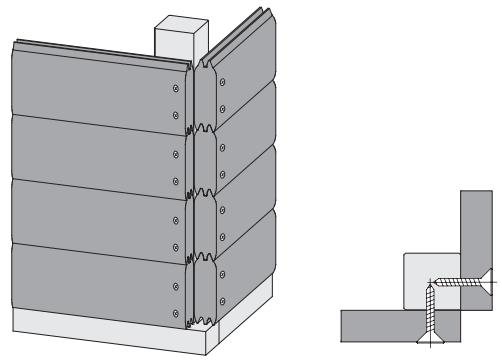

06.2

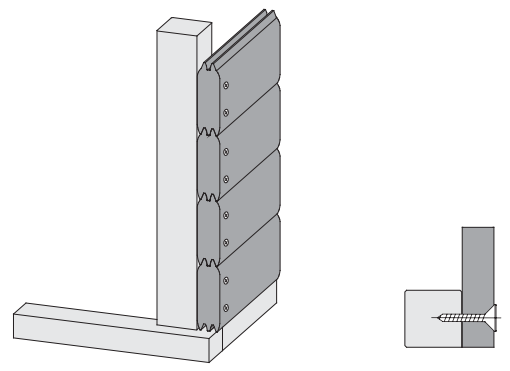

07

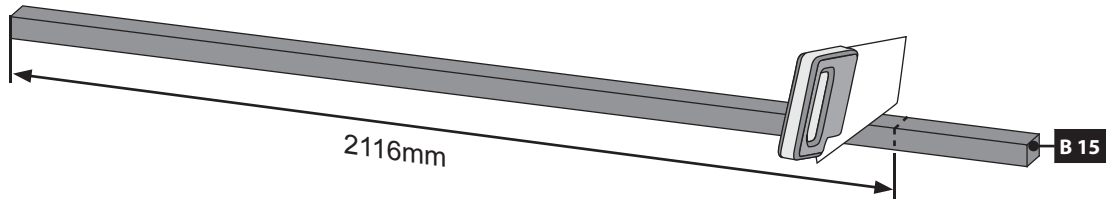

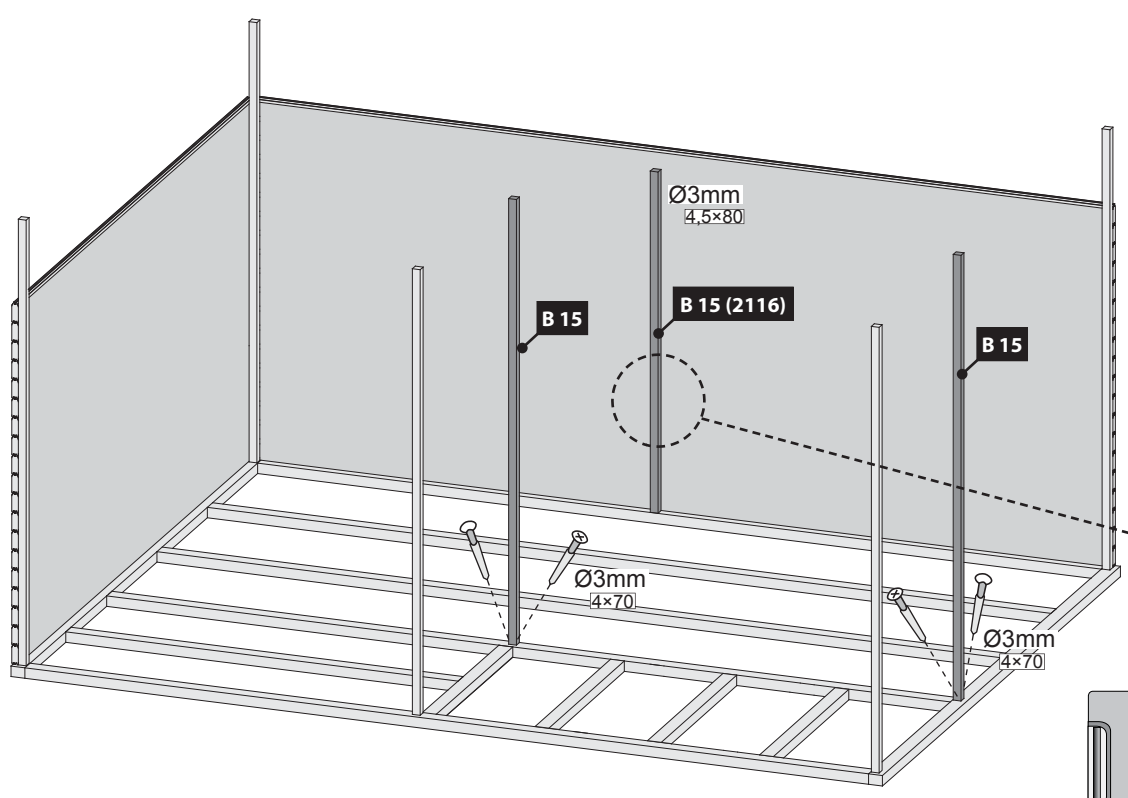



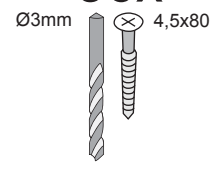

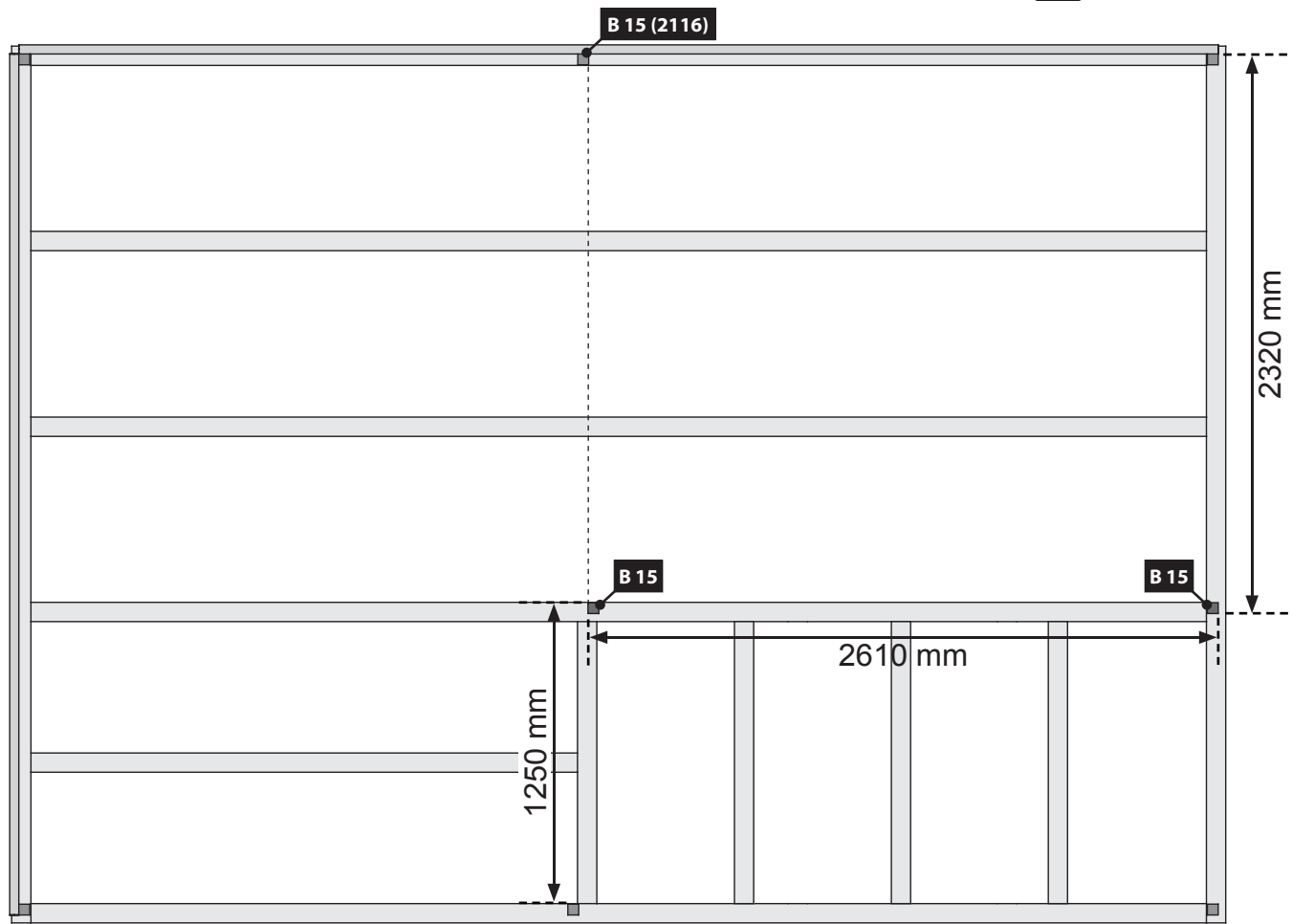
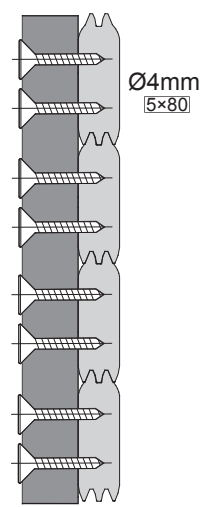
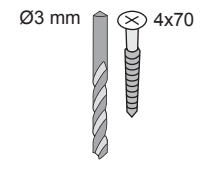

36x





4x



 Leim! Achten Sie auf die gleiche Höhe
 Glue! Look for the same height
 Colle! Faites attention à la même hauteur

 Lijm! Besteed aandacht aan de dezelfde hoogte
 Lim! Vær opmærksom på samme højde
 Pegamento! Prestar atención a la misma altura

 Colla! Prestare attenzione alla stessa altezza
 Klíh! Dávejte pozor na stejnou výšku

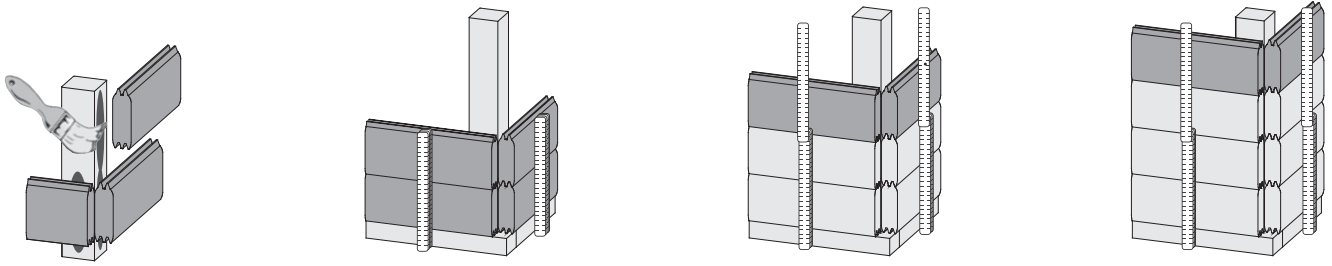

09

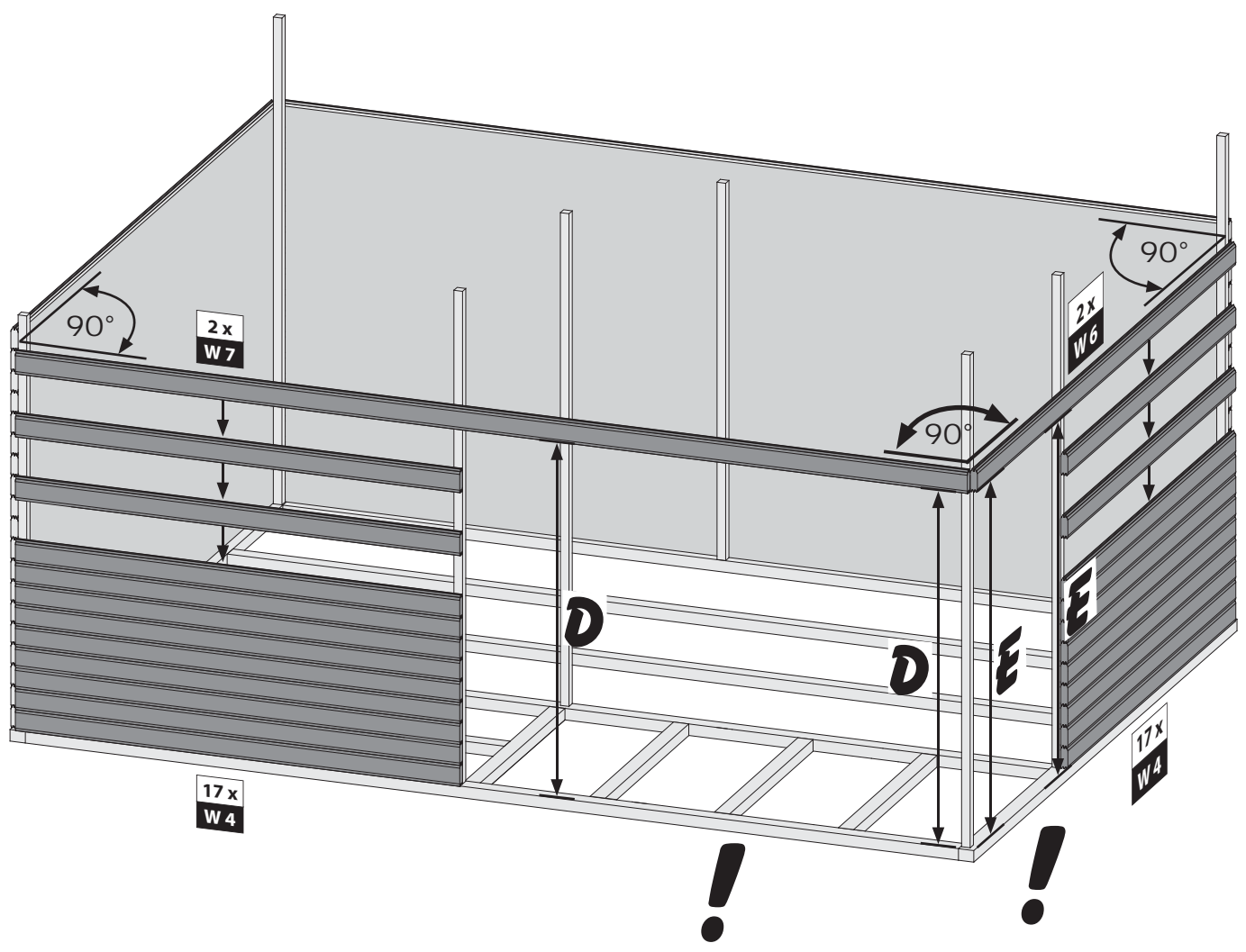
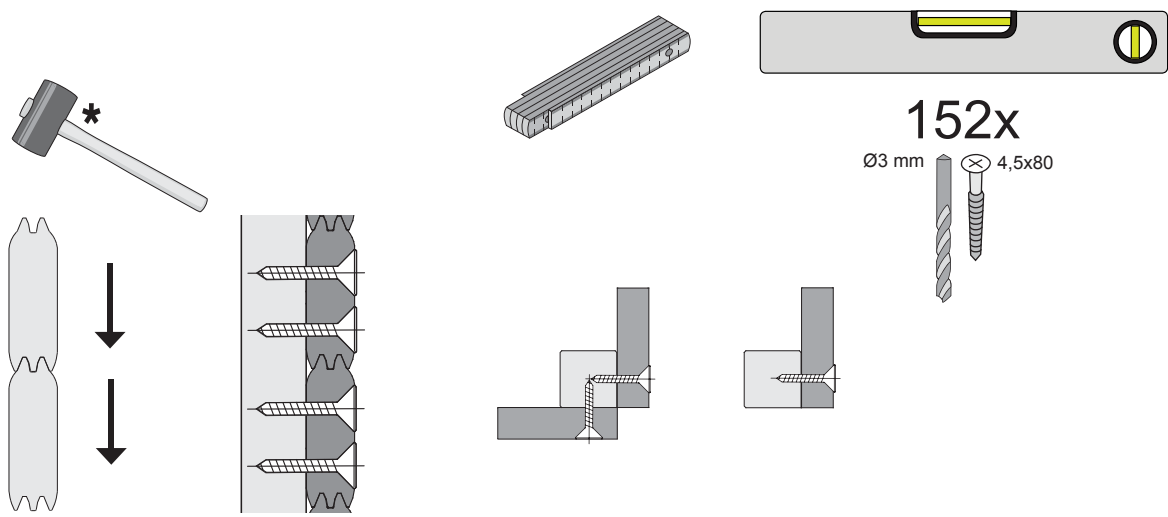

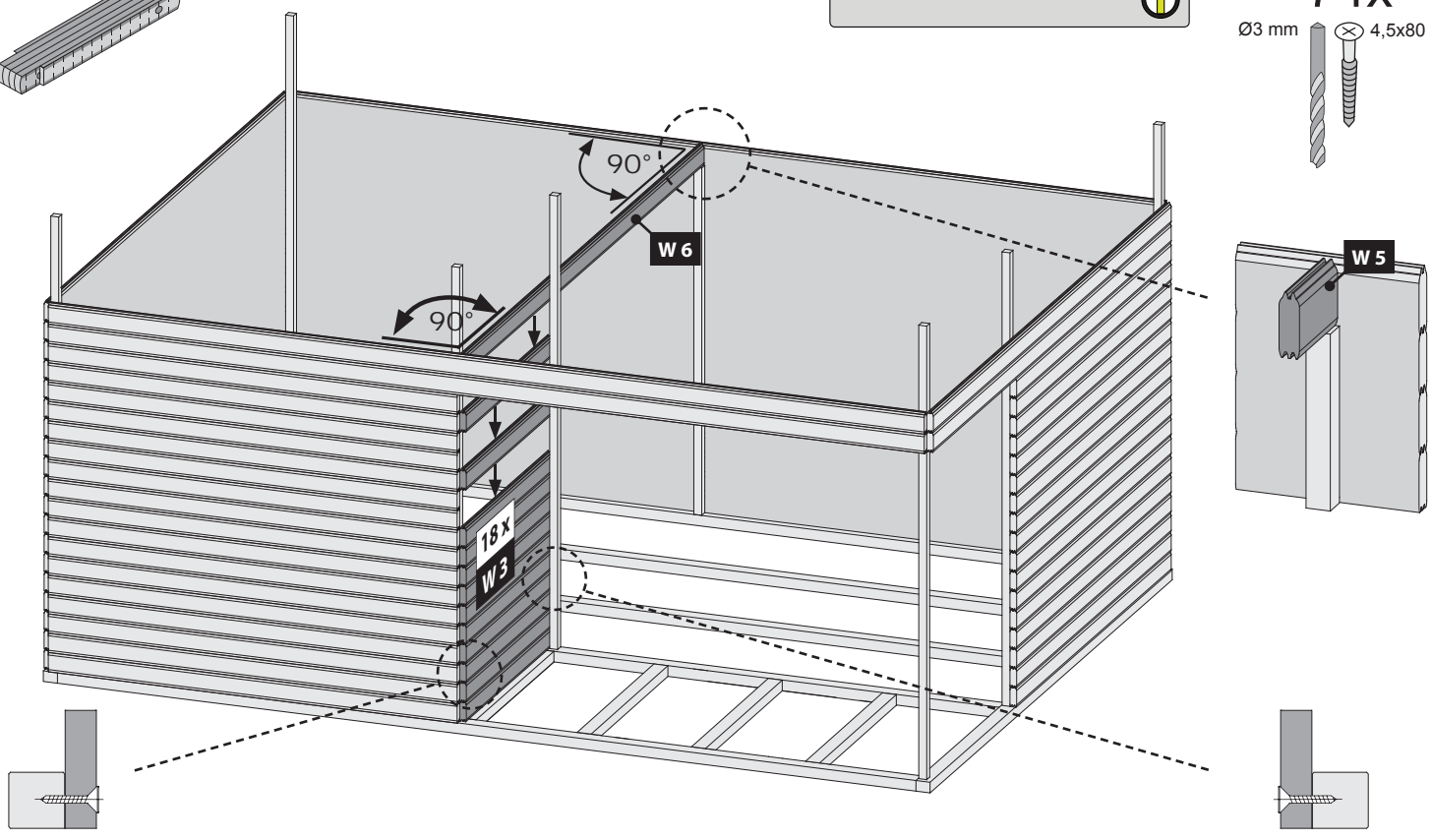
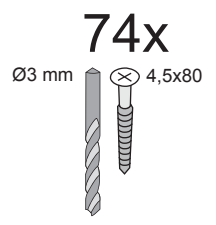
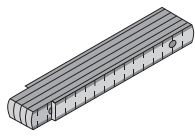

- | | | | |
|--|----------------|--|-----------------|
| | Seitenwand | | sidevæg |
| | Side wall | | pared lateral |
| | paroi latérale | | parete laterale |
| | zijwand | | boční stěna |

11.1

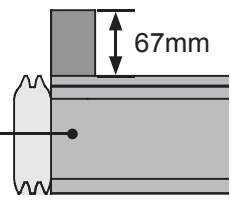

11.2

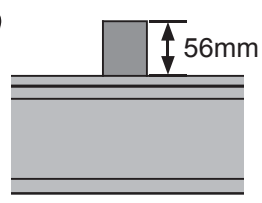



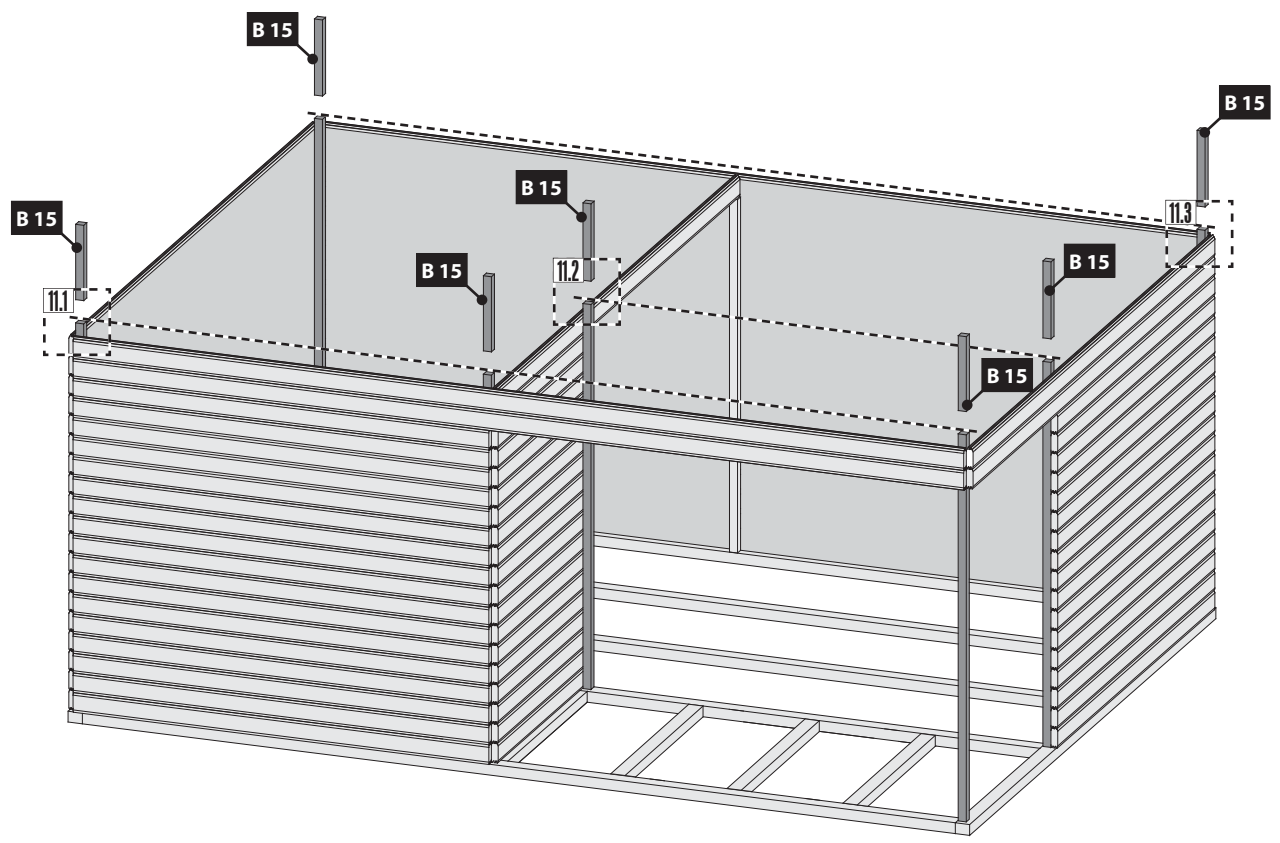
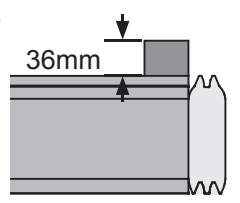

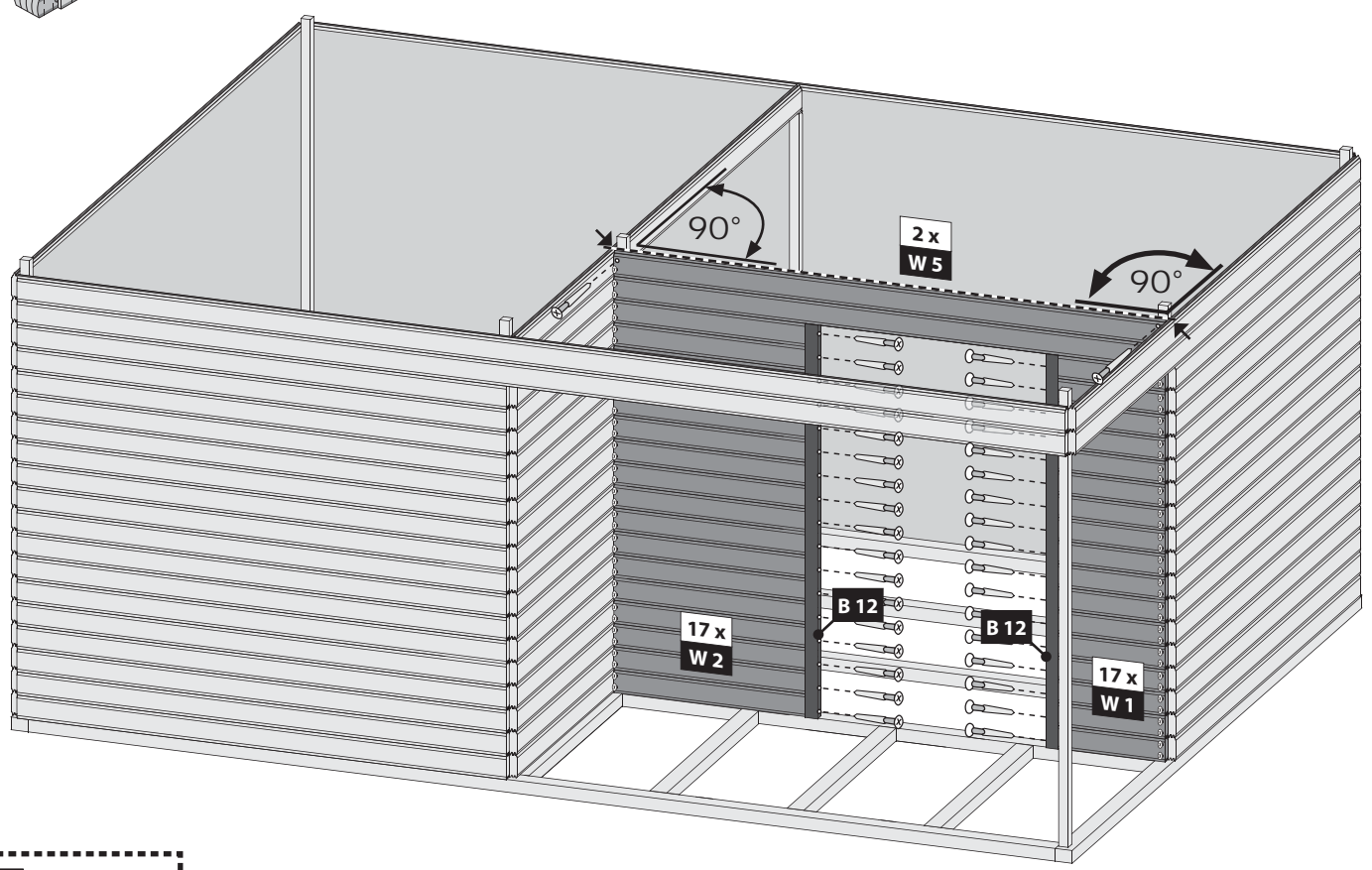
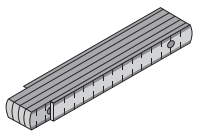

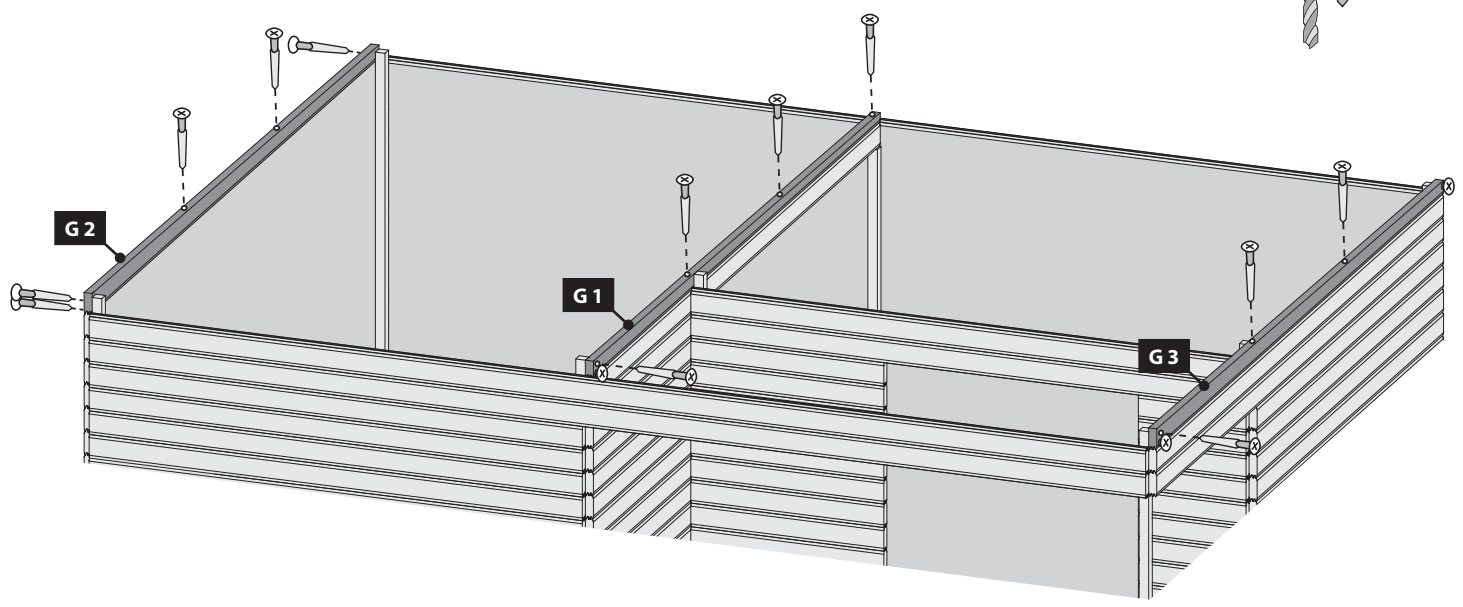
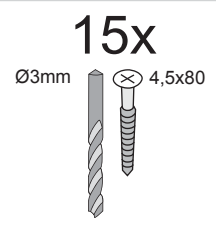
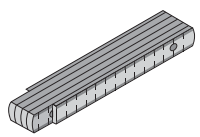
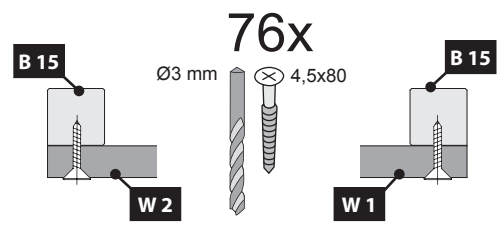
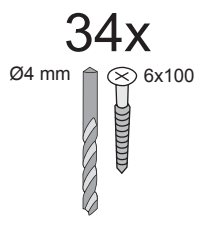
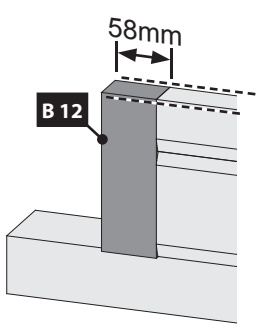

11.3







-  Bündig!
-  Flush!
-  Affleurement!
-  Gelijk!
-  I flugt! ➤
-  Aras!
-  Combacia!
-  Stejný !

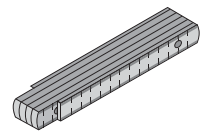
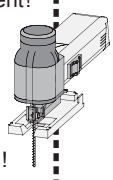

-  Bündig!
-  Flush!
-  Affleurement!
-  Gelijk!
-  I flugt!
-  Aras!
-  Combacia!
-  Stejný!



10x
 Ø3 mm  4,5x80

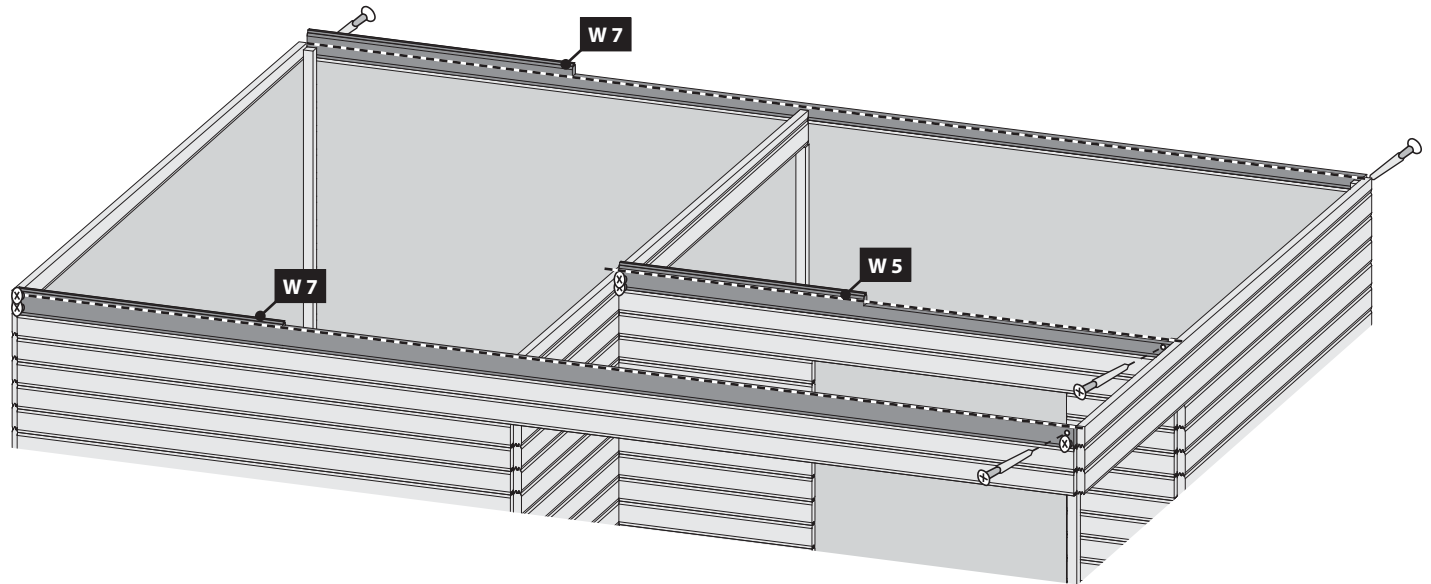

-  ausrichten
-  align
-  aligner

-  richten
-  tilpasse
-  alinear

-  allineare
-  seřadit

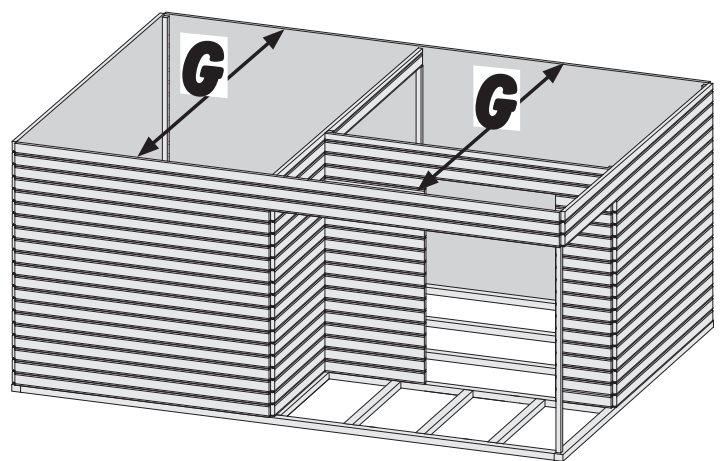
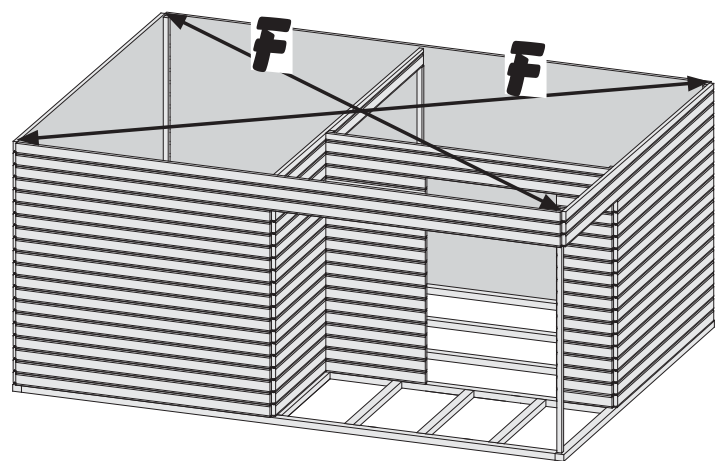
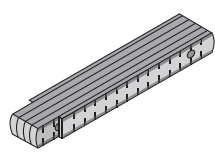



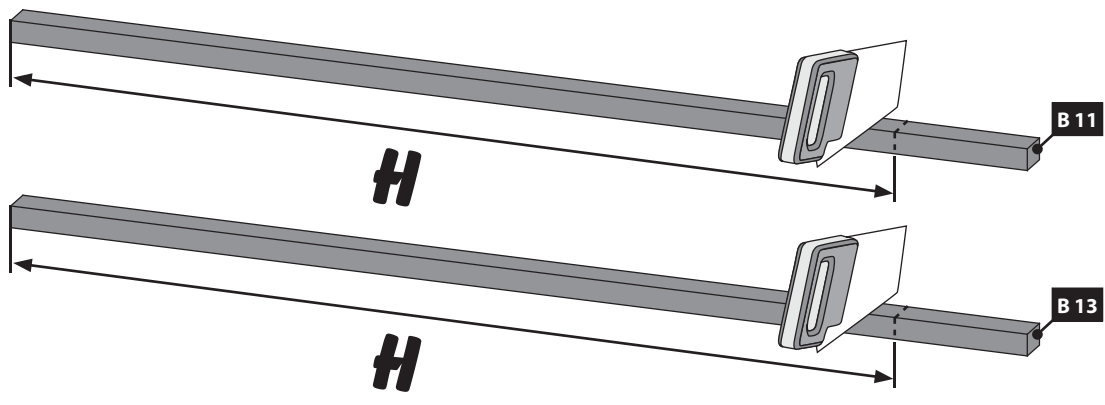
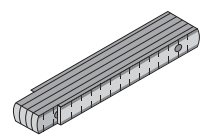
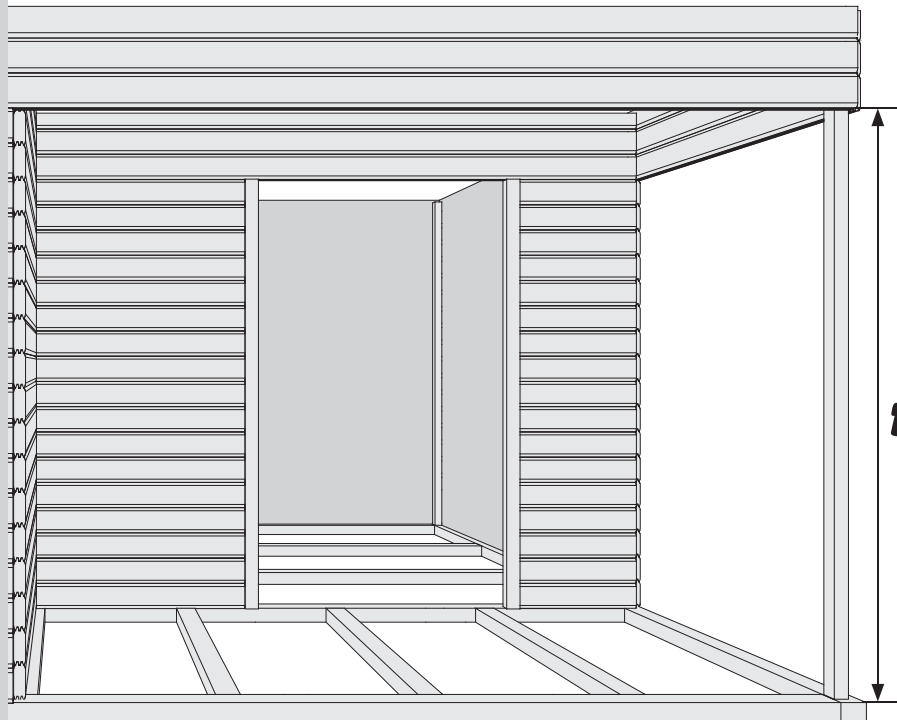

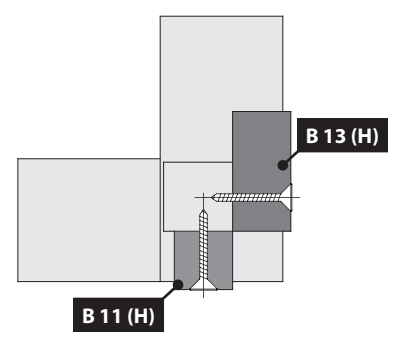
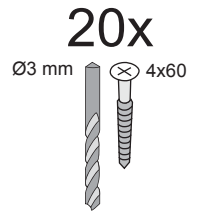
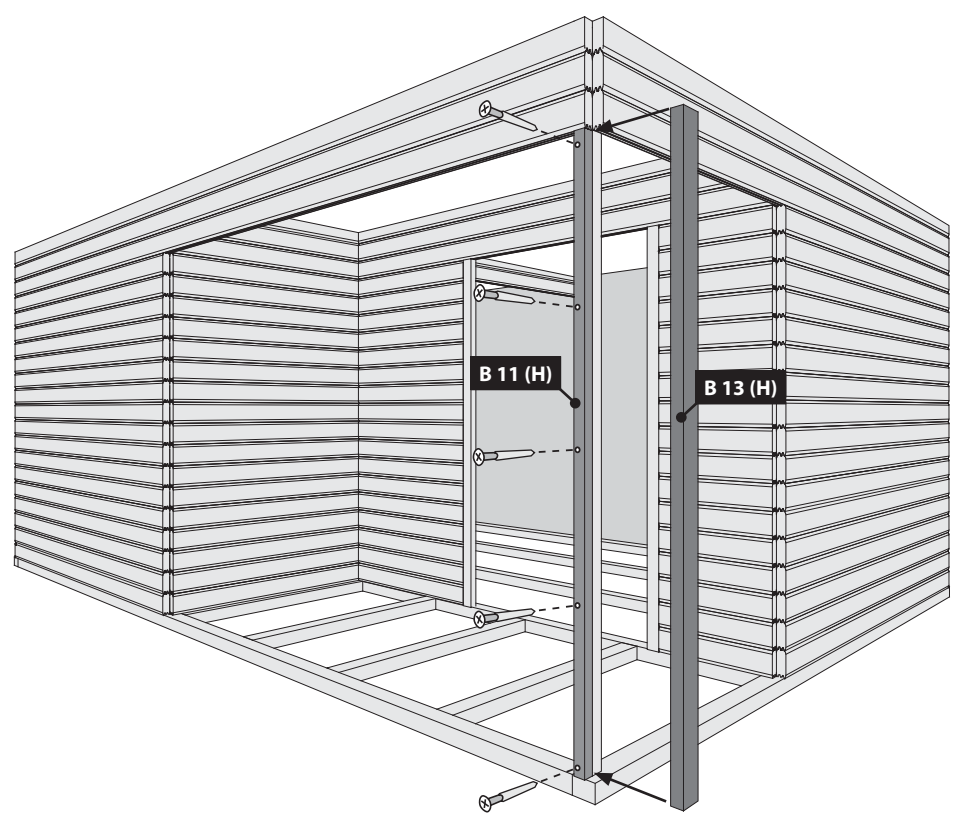

15





16



 Aufbau Fußboden
 Construction of floor
 Construction du plancher

 Bouw van de vloer
 Byggeri af gulv
 Construcción de piso

 Costruzione di pavimento
 Výstavba podlahy

17



 Breite Seite nach oben
 Width side up
 Largeur vers le haut
 Breedte side up
 Ancho de banda de hasta
 Larghezza verso l'alto
 Šířka stranou nahoru

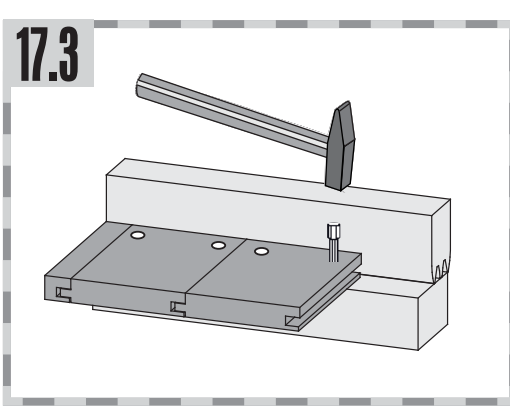
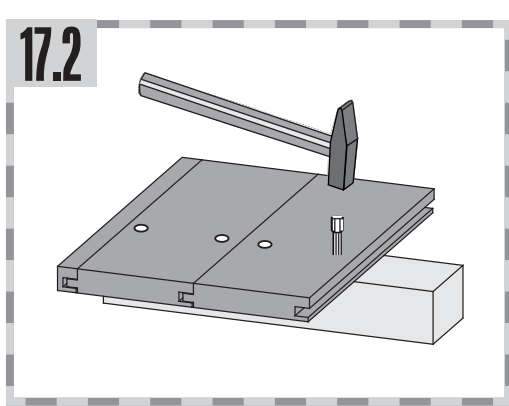
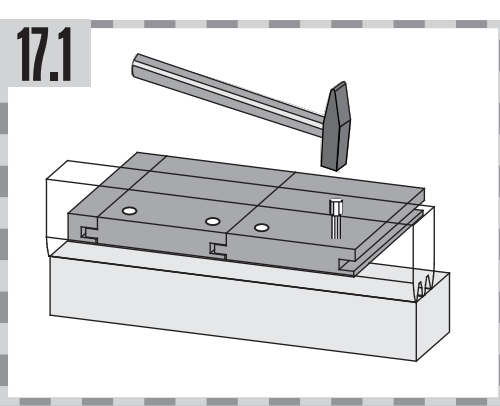
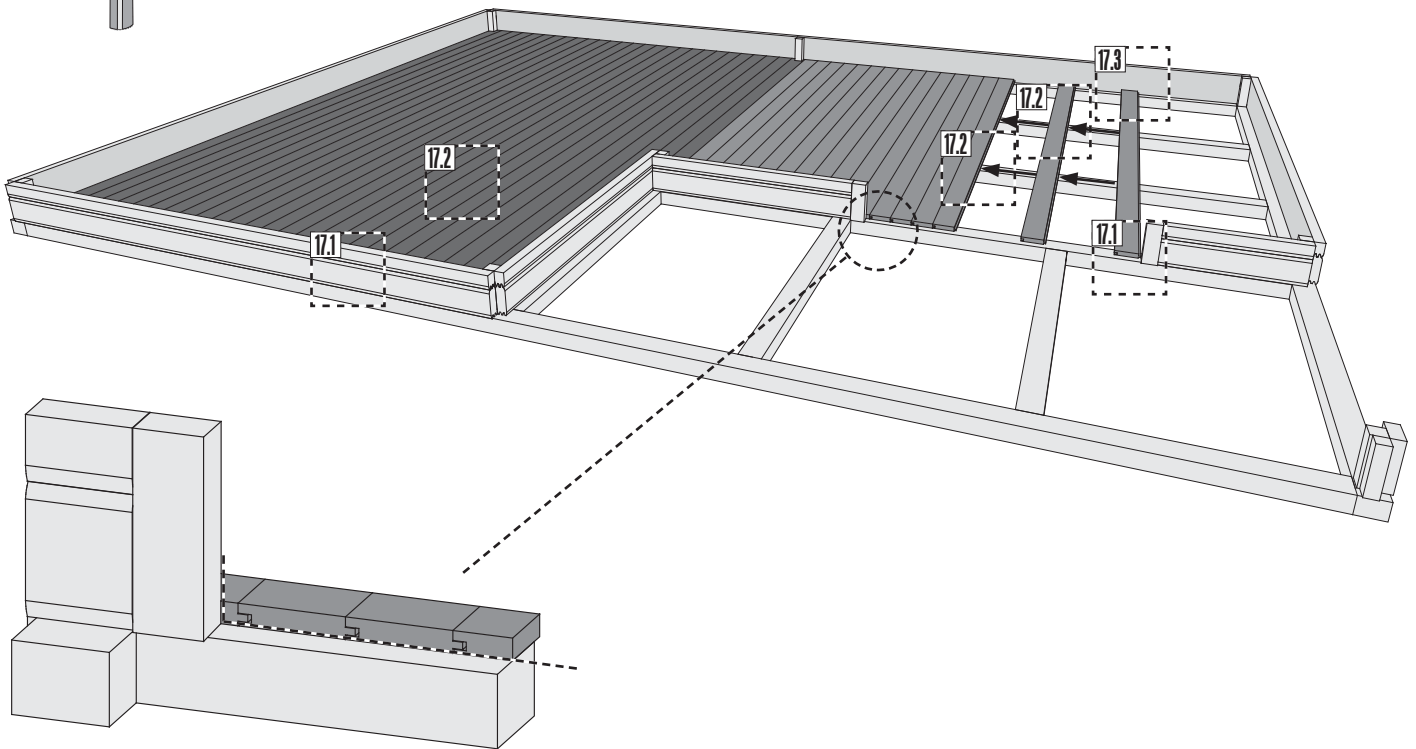
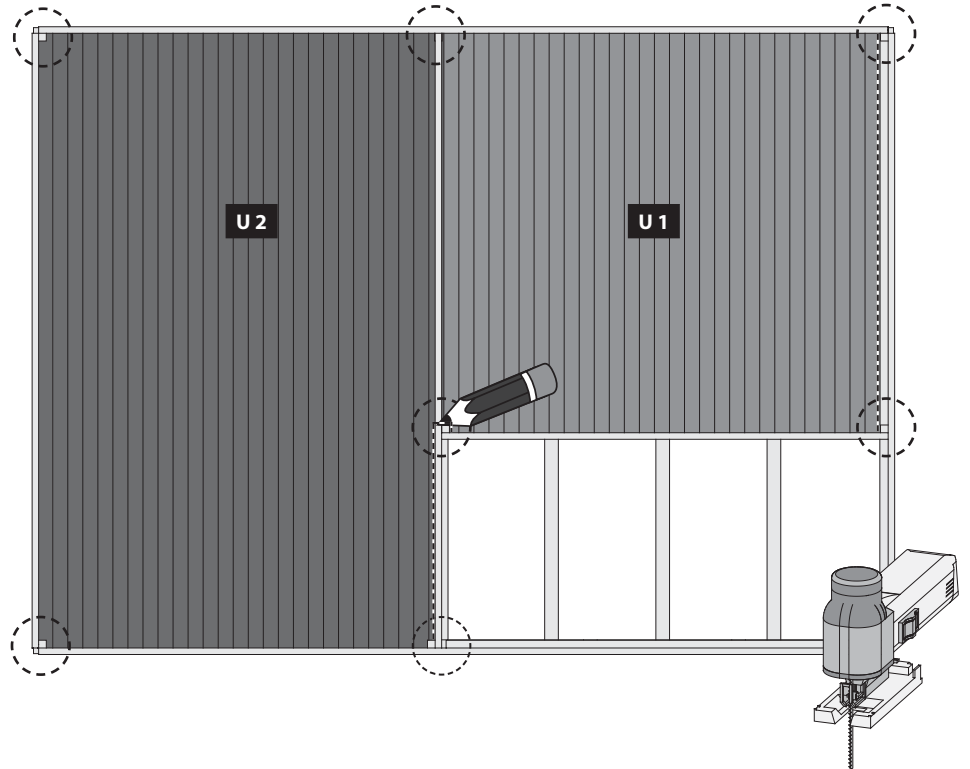
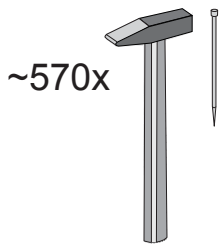

Ø3 mm 4x70

38x

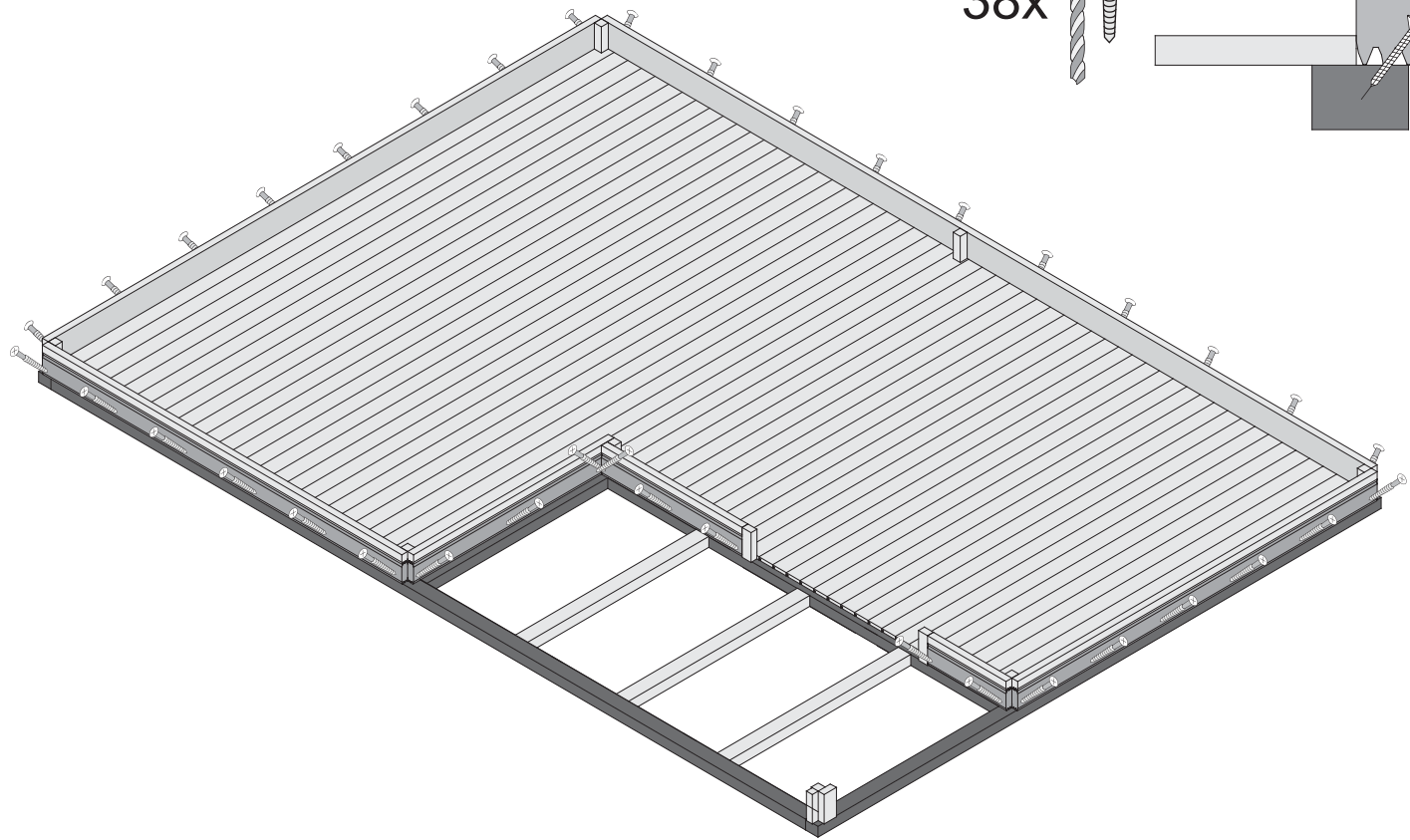
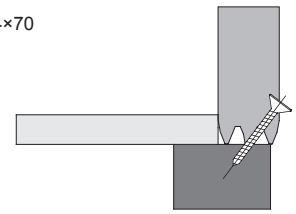

Ø3 mm 4x50

20x

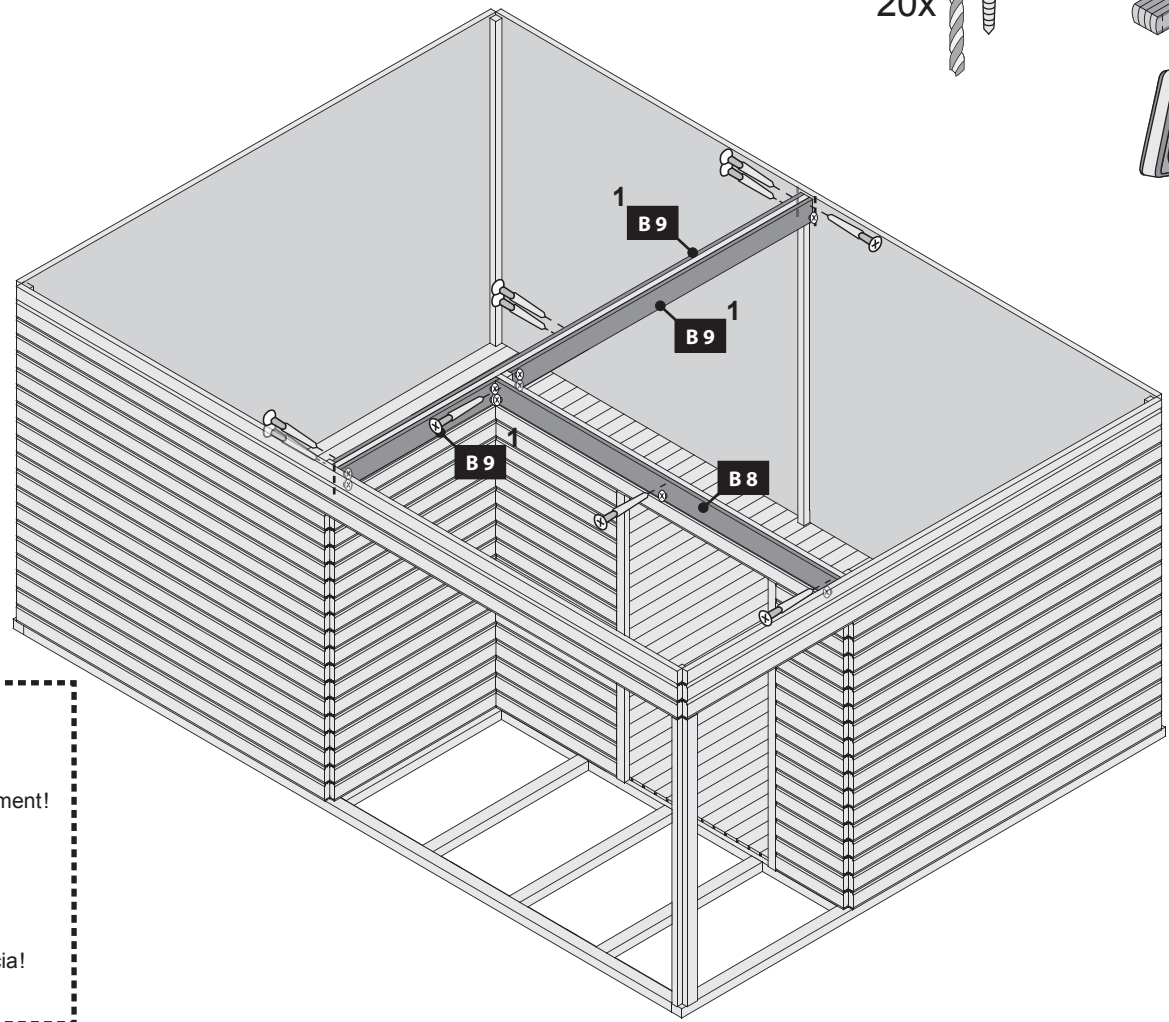
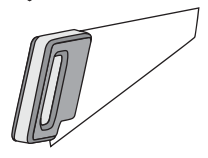
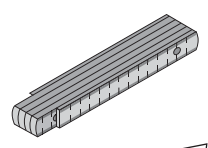

-  Bündig!
-  Flush!
-  Affleurement!
-  Gelijk!
-  I flugt!
-  Aras!
-  Combacia!
-  Stejný !

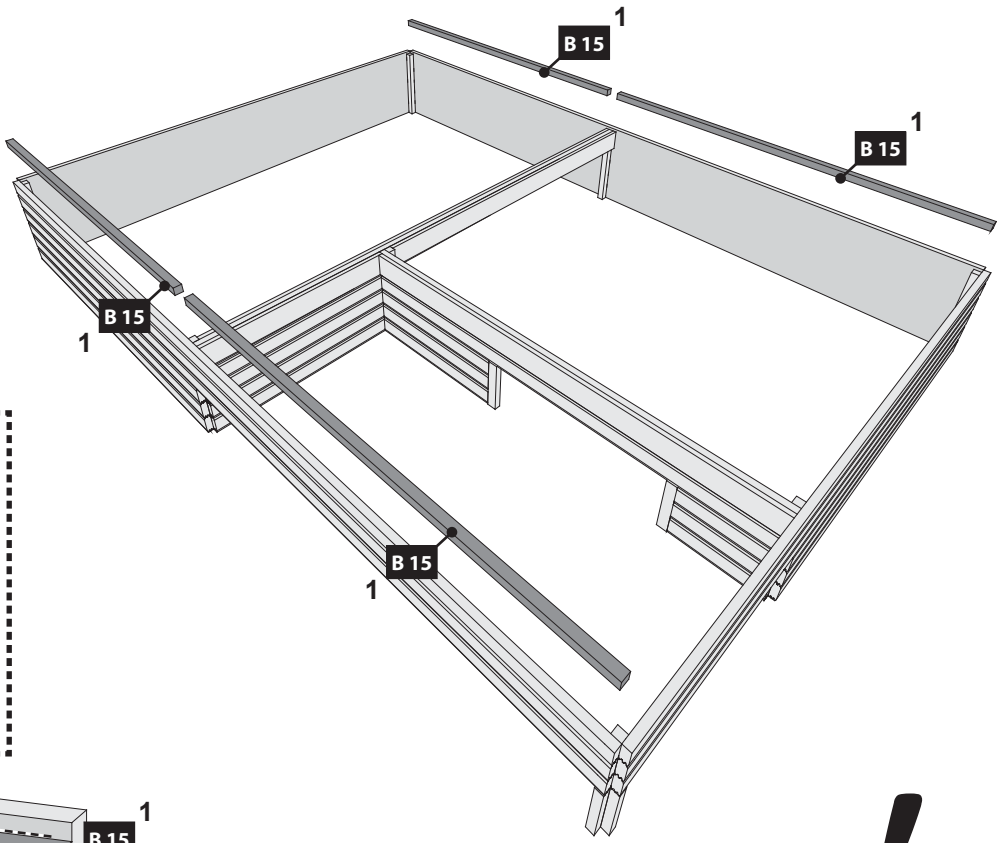
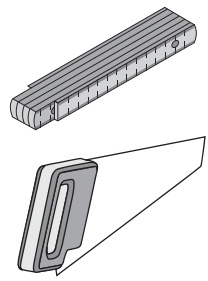

-  Bündig!
-  Flush!
-  Affleurement!
-  Gelijk!
-  I flugt!
-  Aras!
-  Combacia!
-  Stejný !

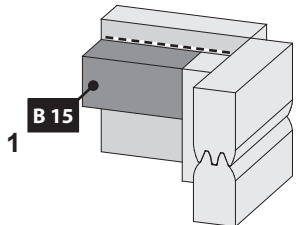
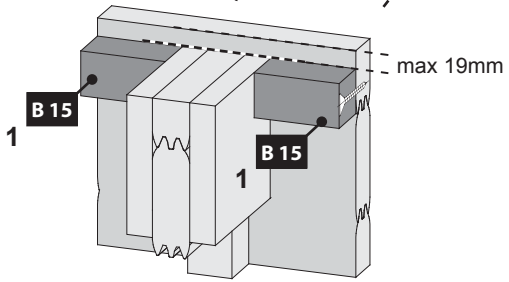
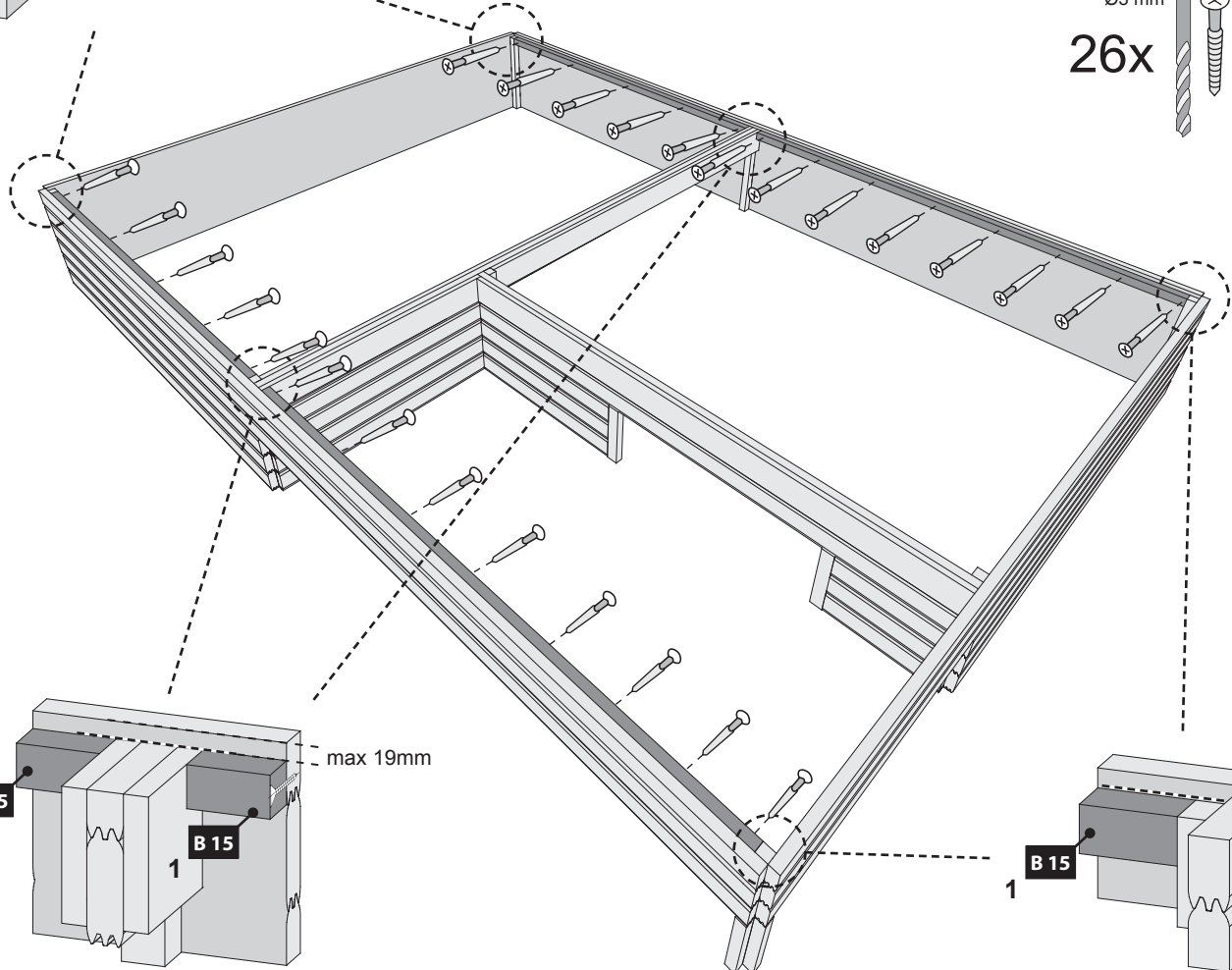
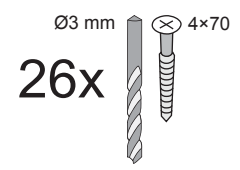
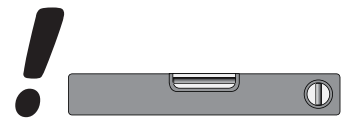
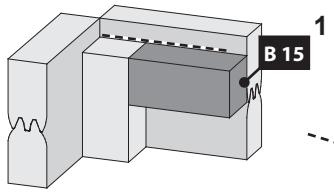

21 6x

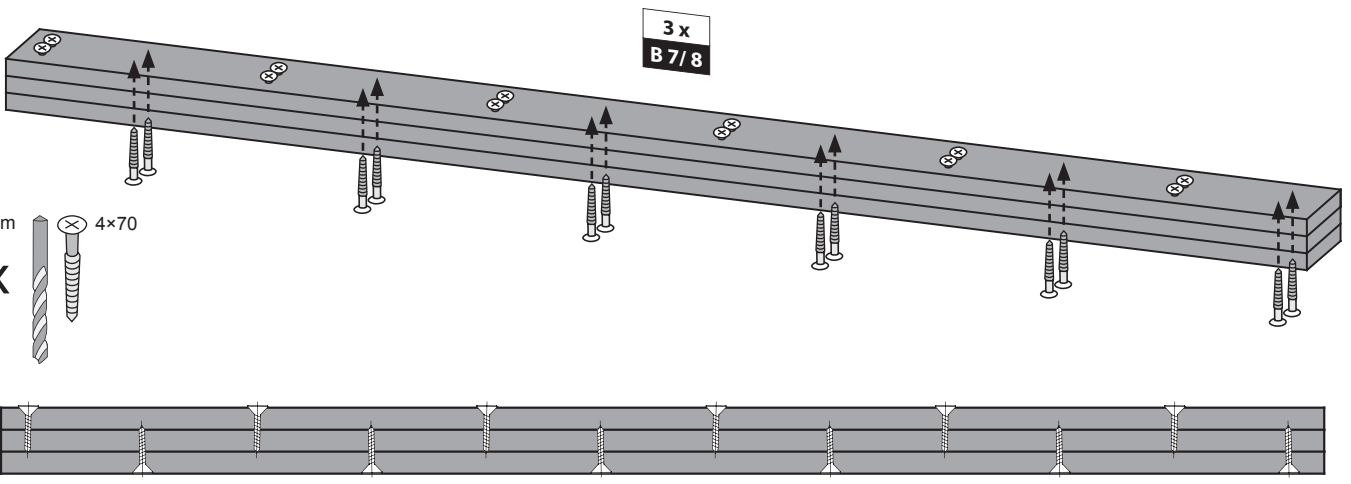

22



96x

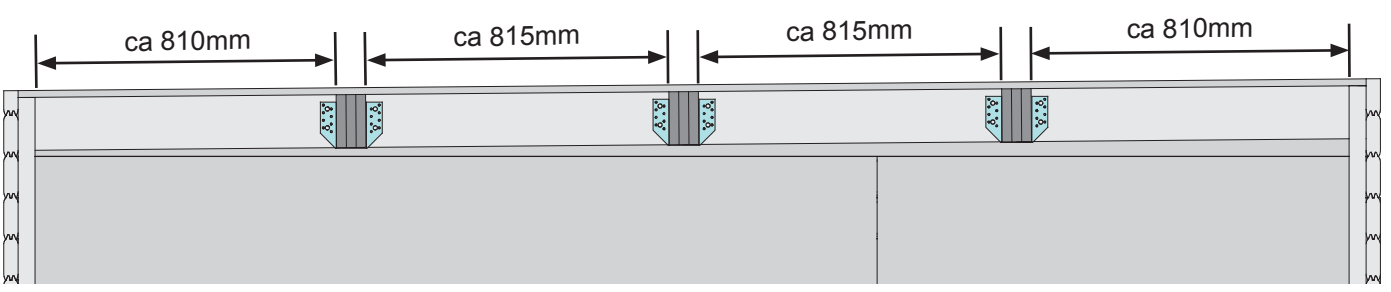
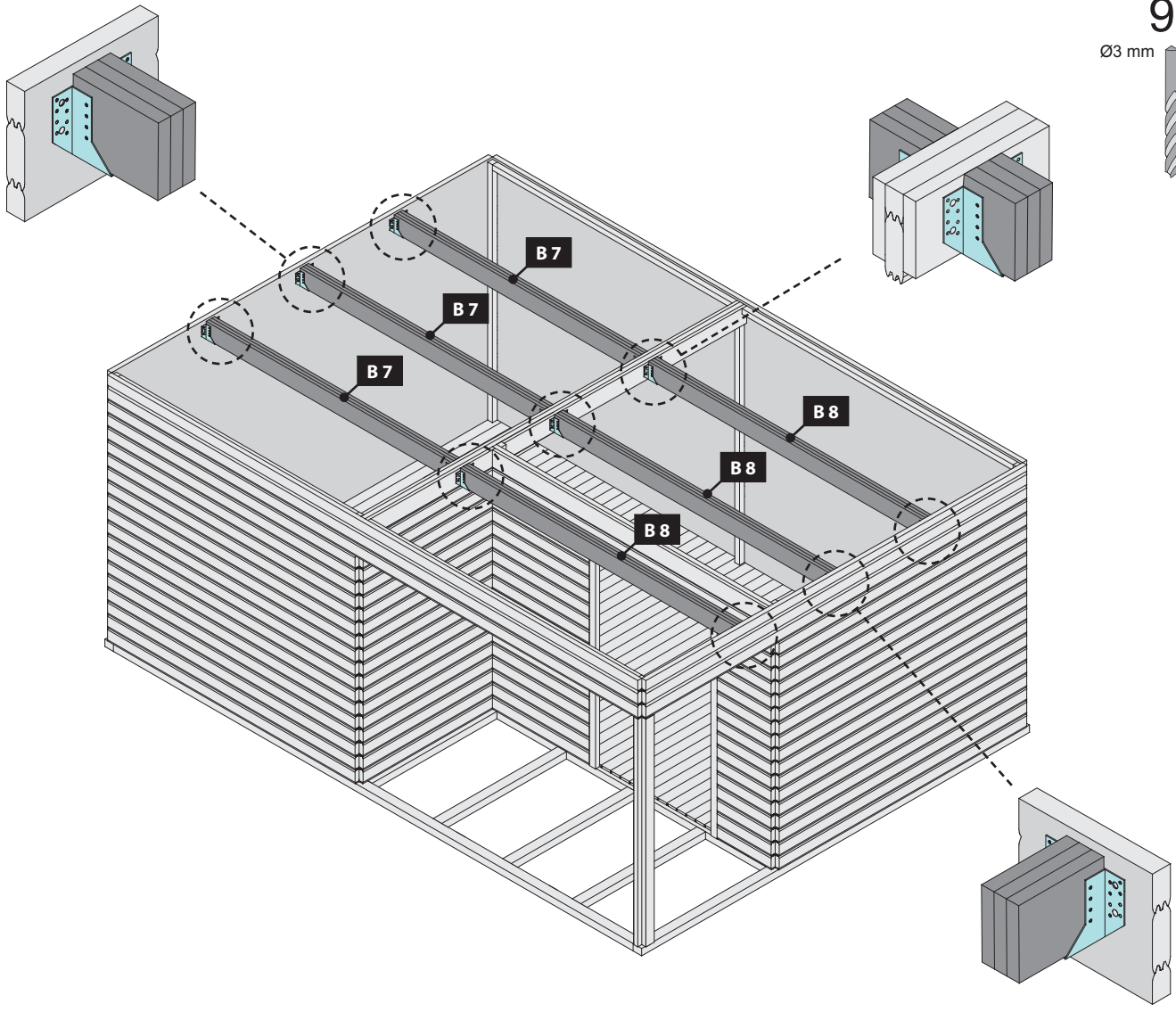
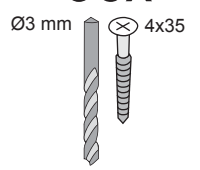

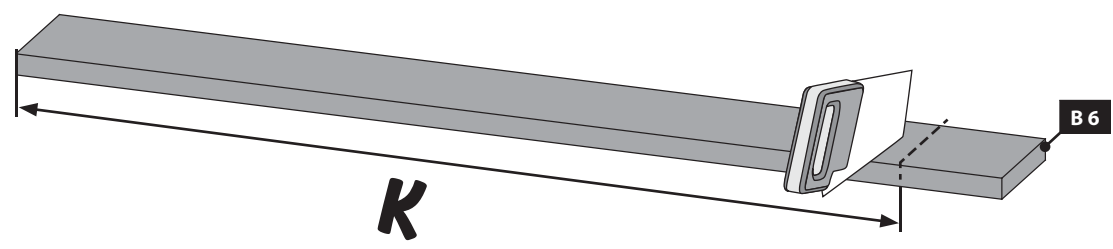
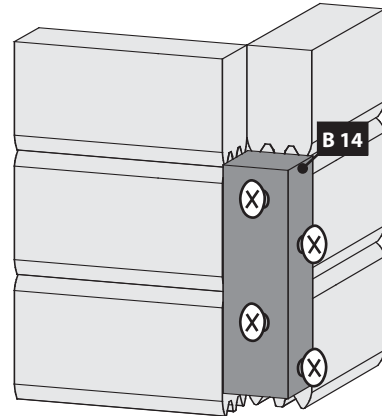
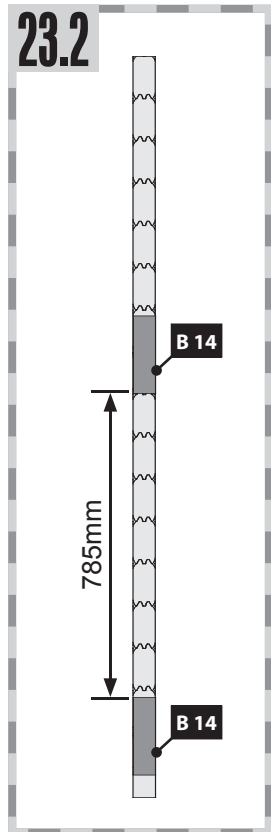
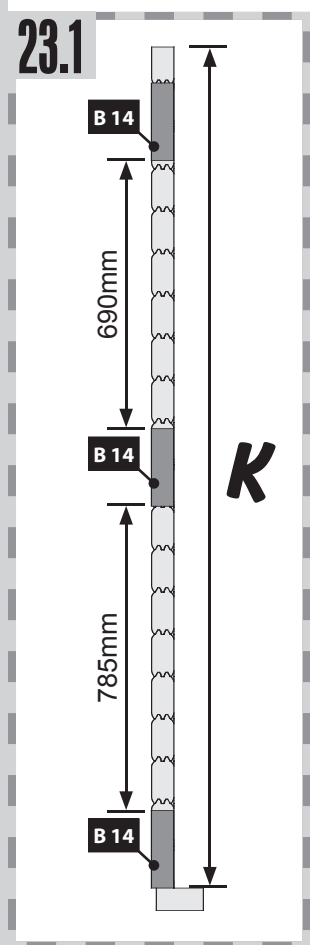
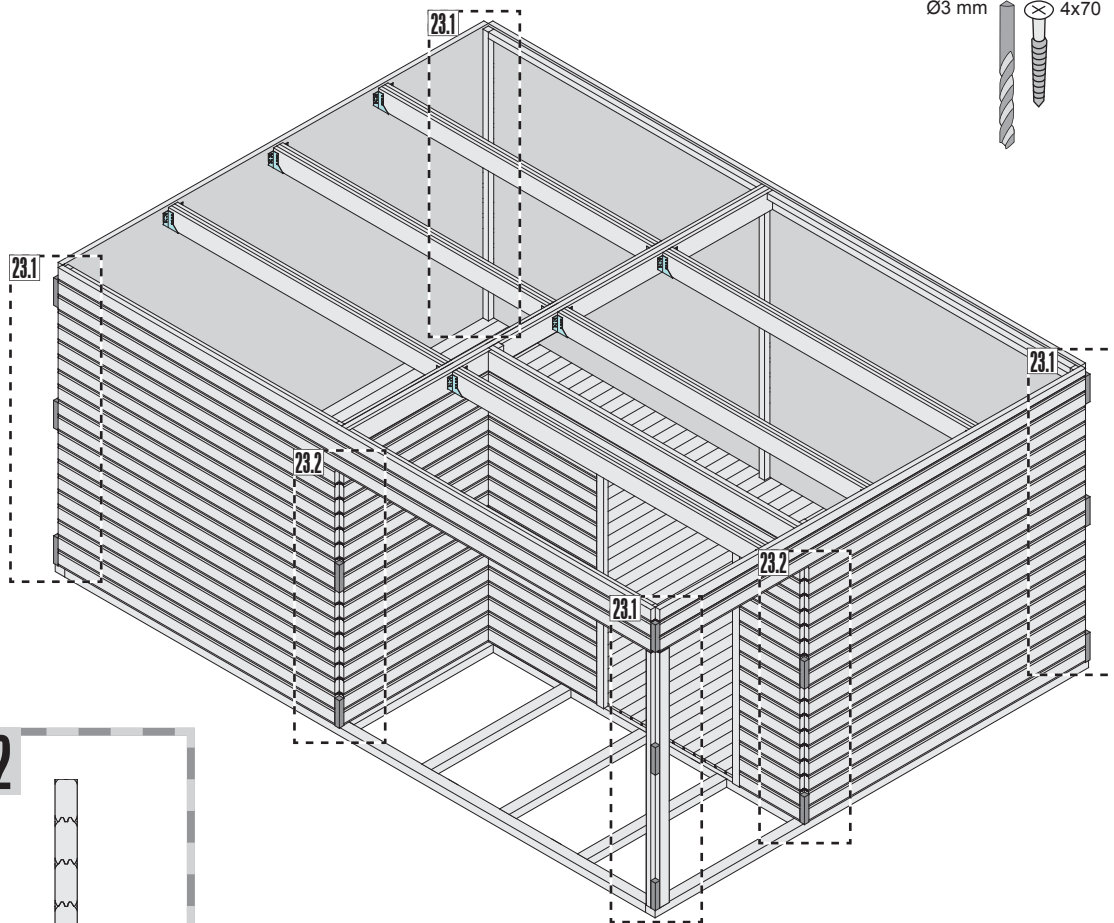
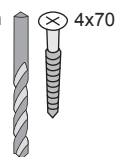

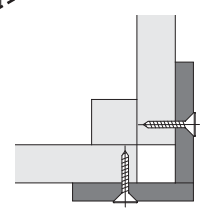
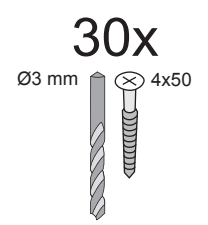
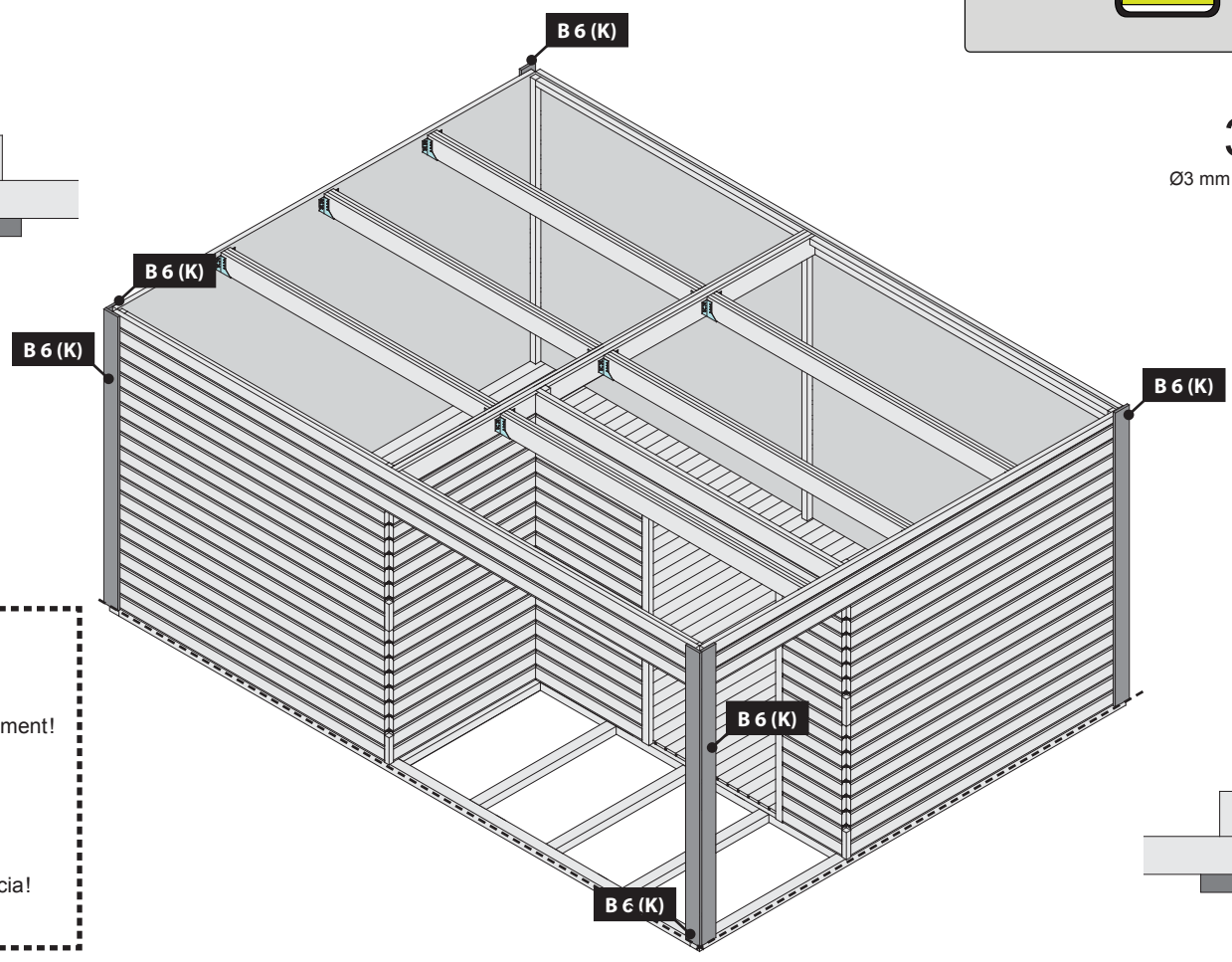
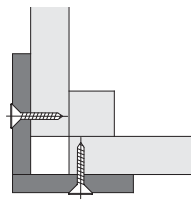

-  Bündig!
-  Flush!
-  Affleurement!
-  Gelijk!
-  I flugt!
-  Aras!
-  Combacia!
-  Stejný !

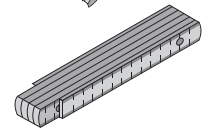
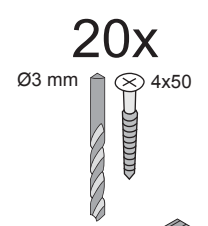
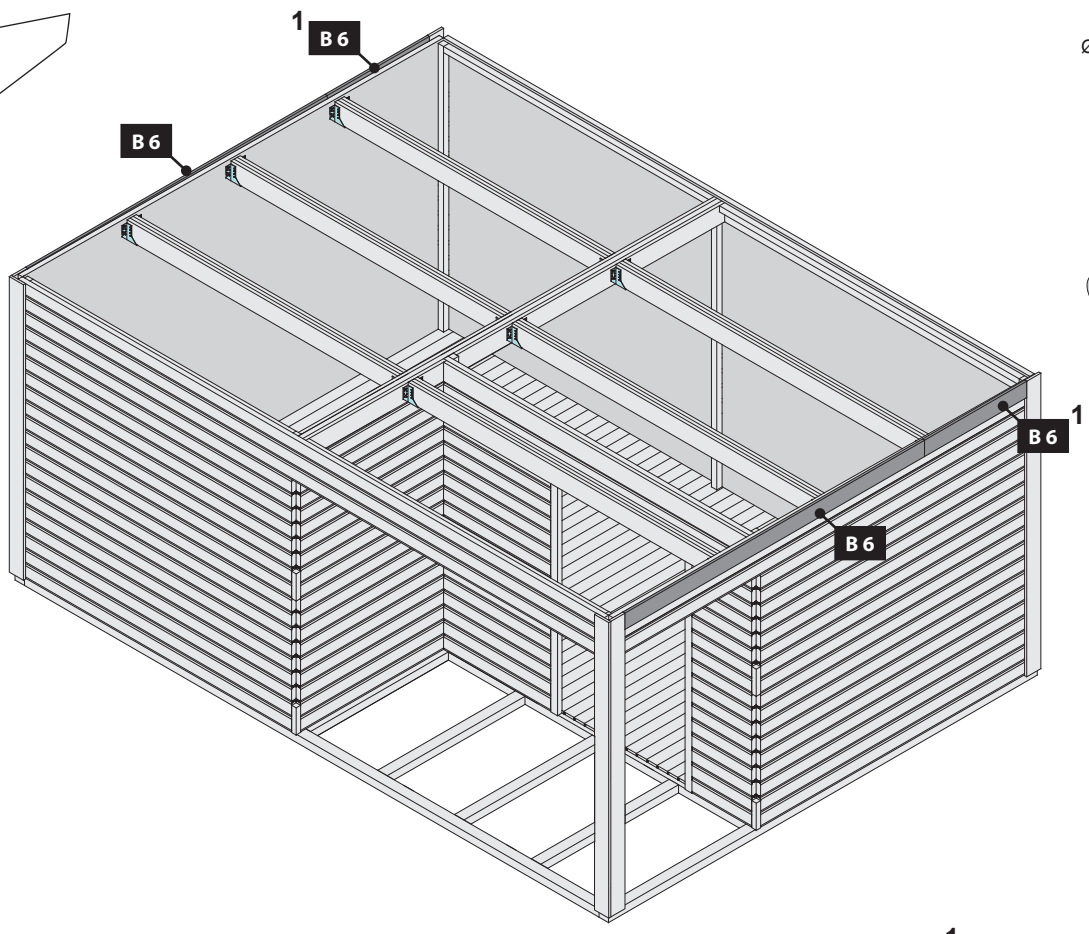
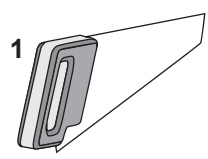

-  Bündig!
-  Flush!
-  Affleurement!
-  Gelijk!
-  I flugt!
-  Aras!
-  Combacia!
-  Stejný !



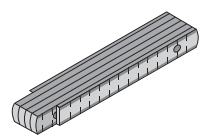

2x

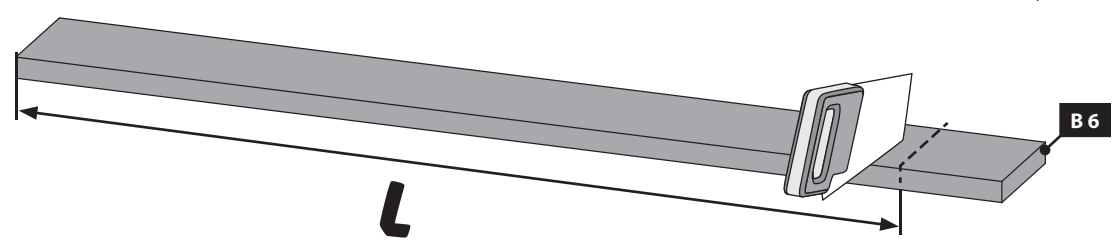

L

B 6

L

!

L

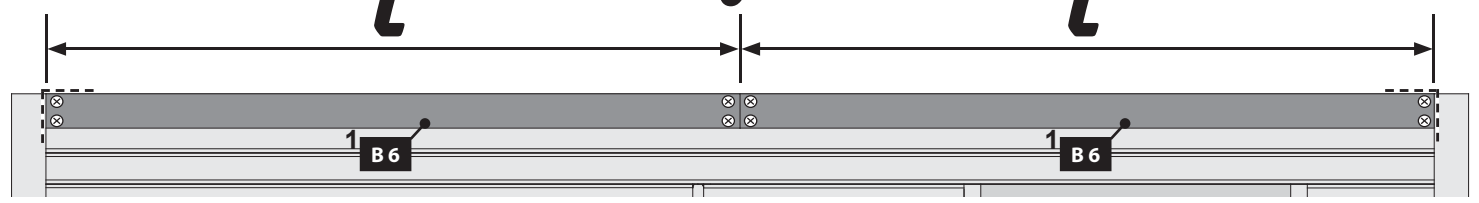

B 6

B 6

-  Bündig!
-  Flush!
-  Affleurement!
-  Gelijk!
-  I flugt!
-  Aras!
-  Combacia!
-  Stejný !

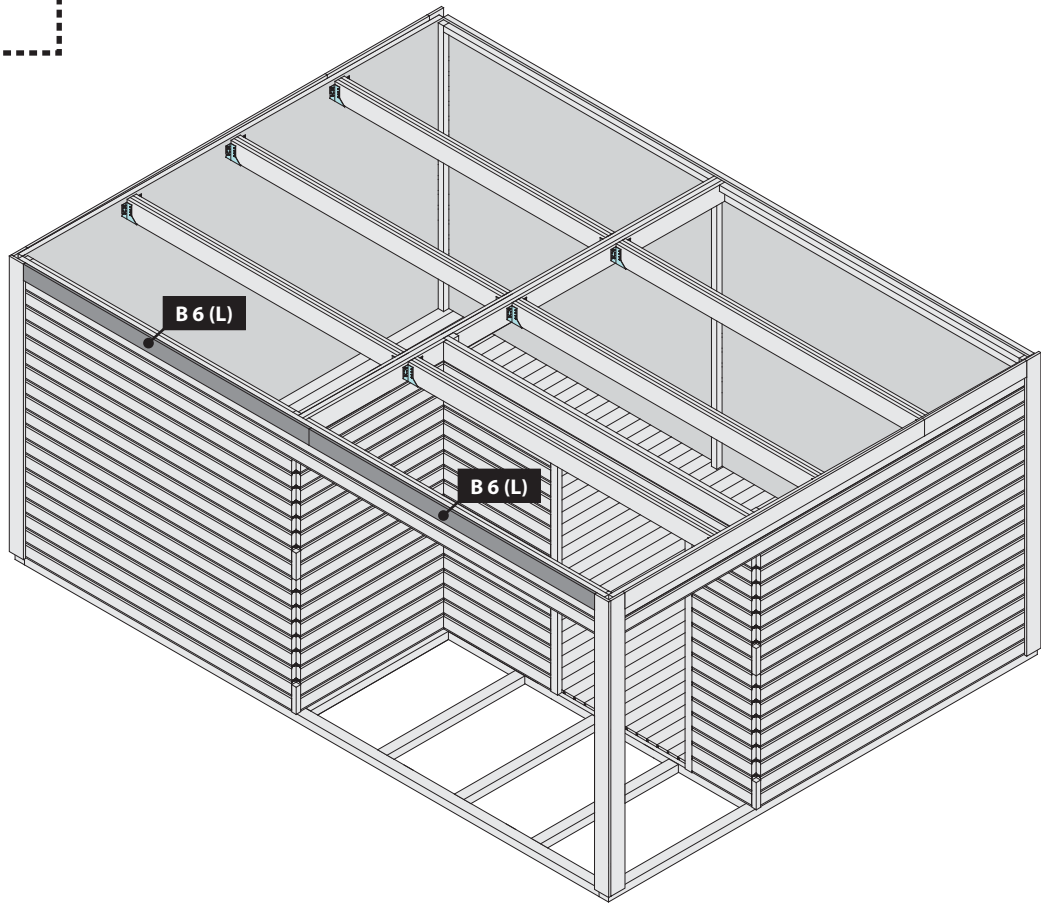
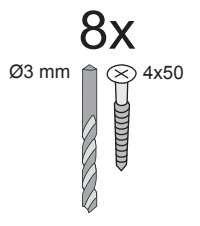

B 6 (L)

B 6 (L)

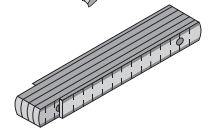
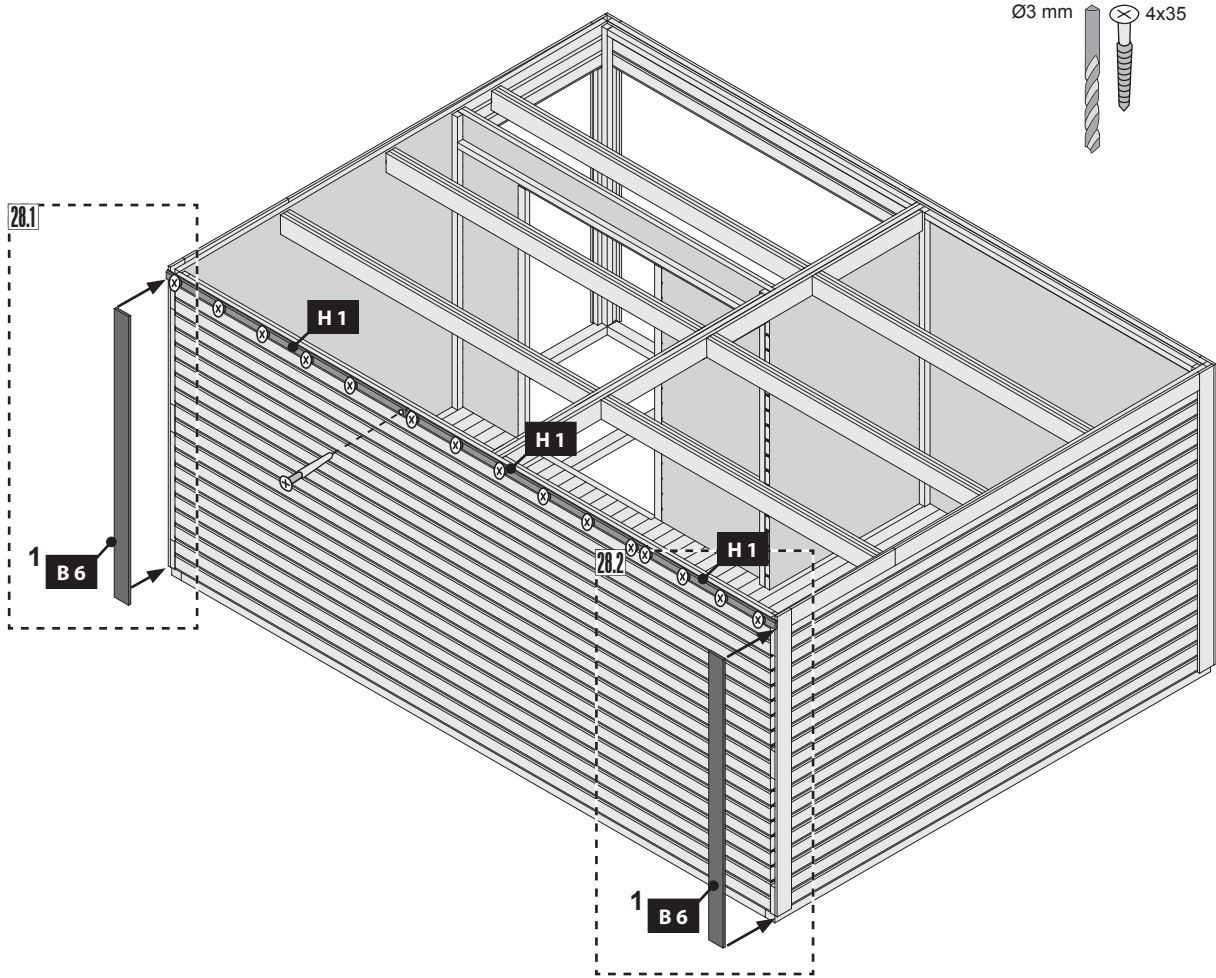
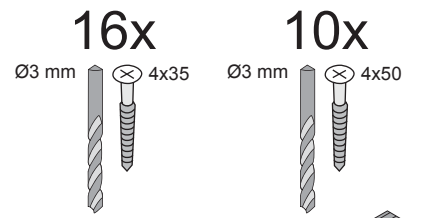

28.1

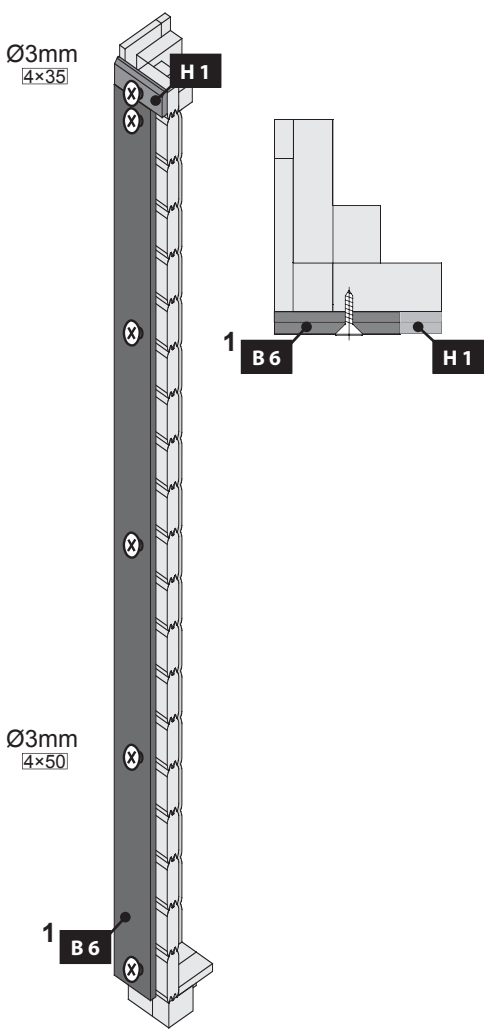

28.2

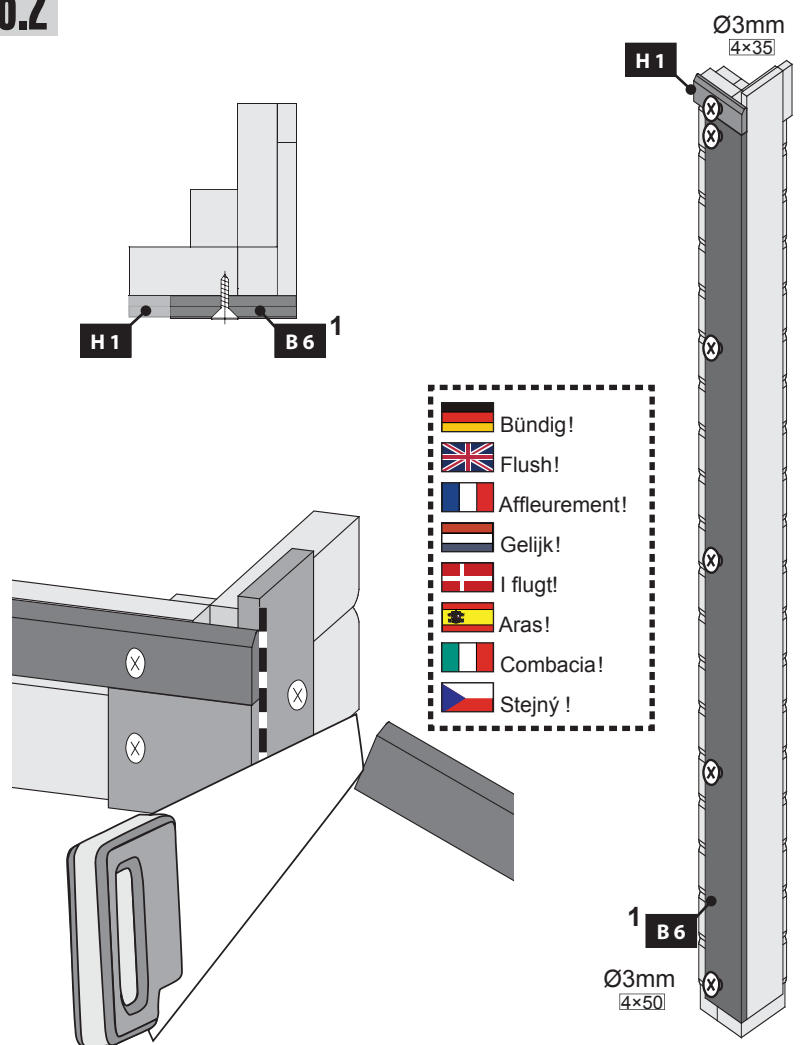

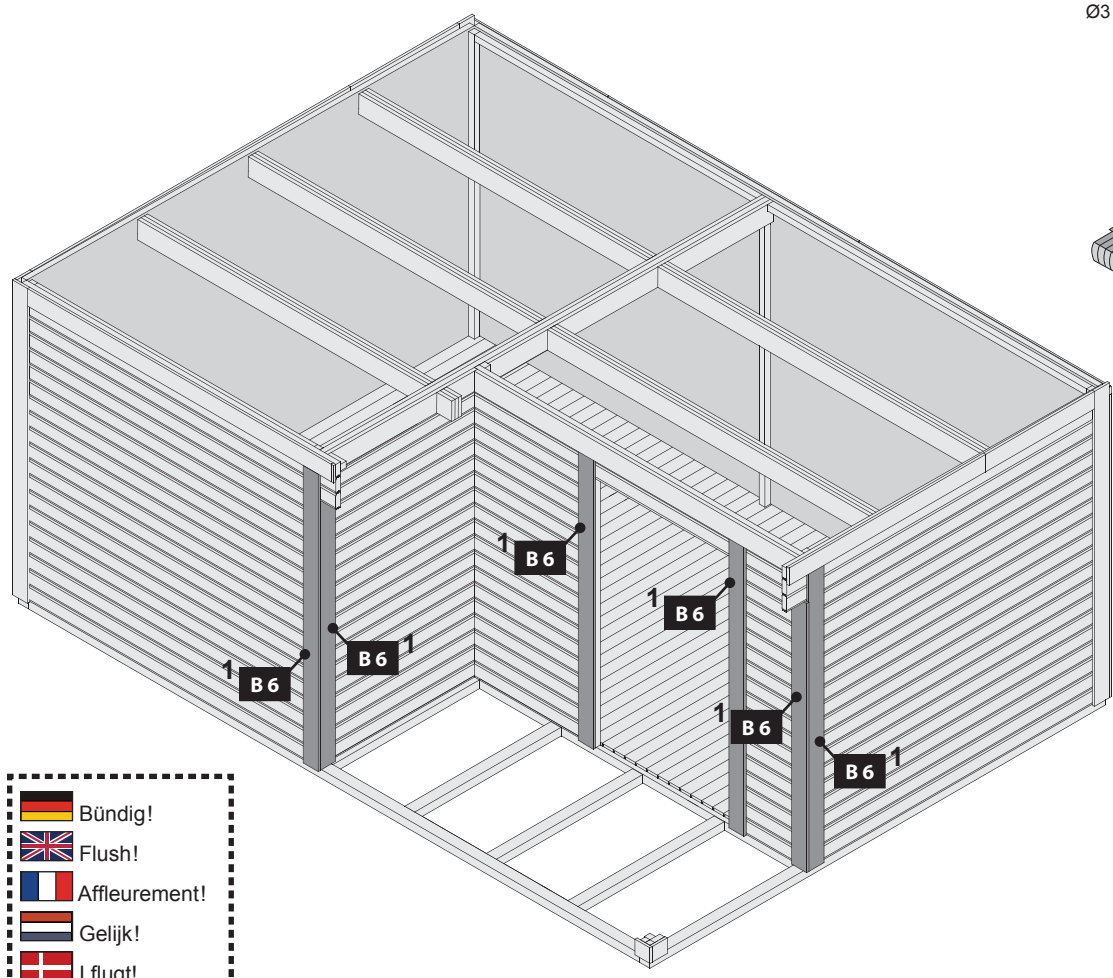
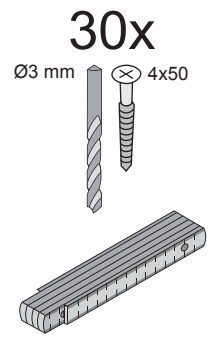

-  Bündig!
-  Flush!
-  Affleurement!
-  Gelijk!
-  I flugt!
-  Aras!
-  Combacia!
-  Stejný!

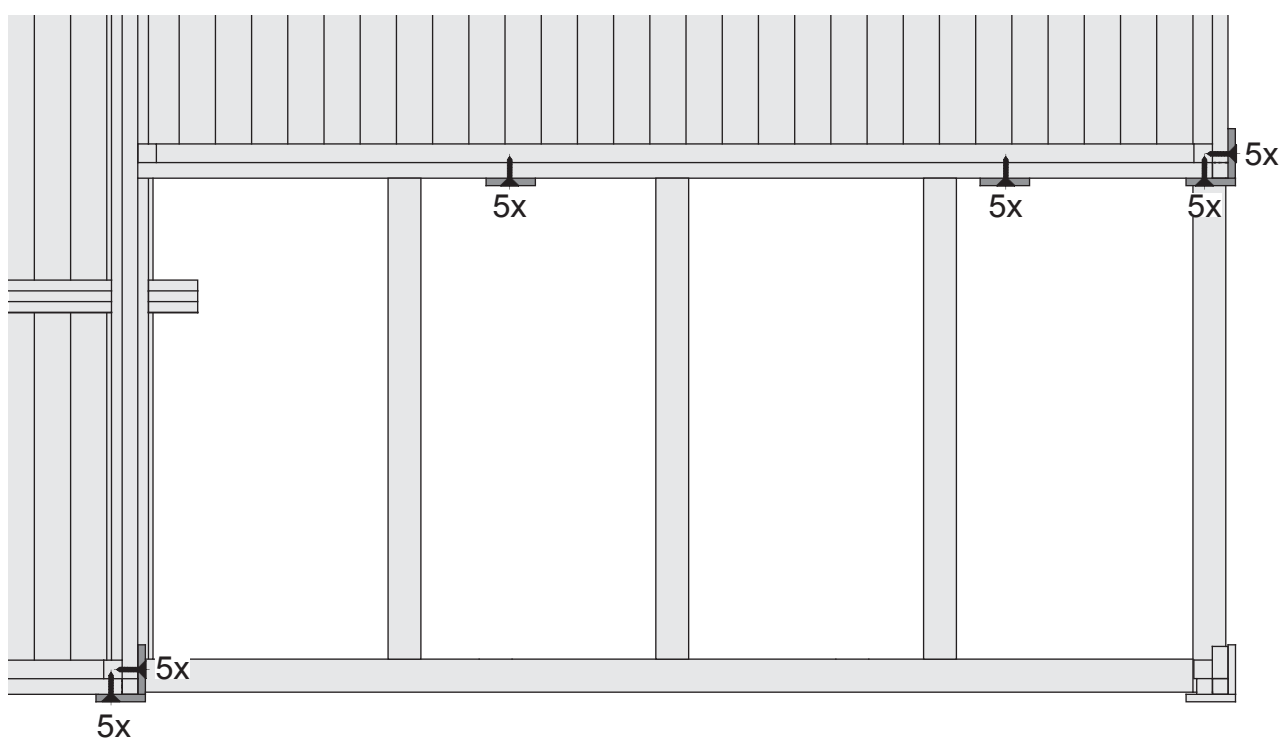

-  Bündig!
-  Flush!
-  Affleurement!
-  Gelijk!
-  I flugt!
-  Aras!
-  Combacia!
-  Stejný !



-  Schmale Seite nach oben
-  Narrow side up
-  Narrow vers le haut
-  Smalle kant naar boven
-  Smal side op

-  Estrecha hacia arriba
-  Stretta verso l'alto
-  Úzká stranou nahoru

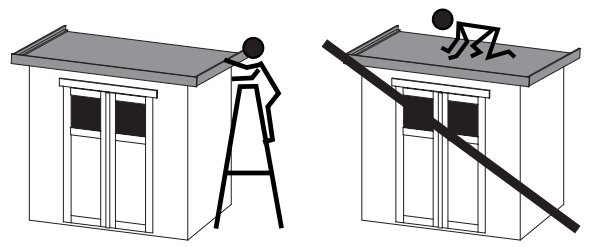

30

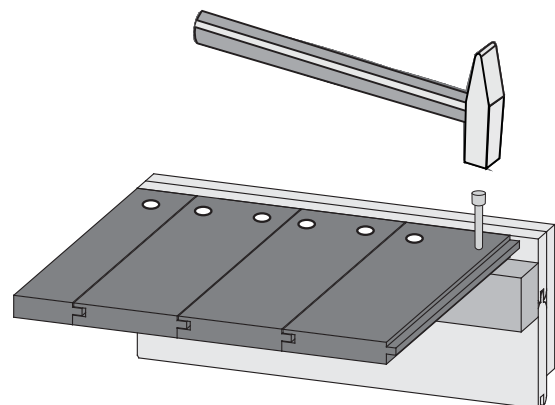
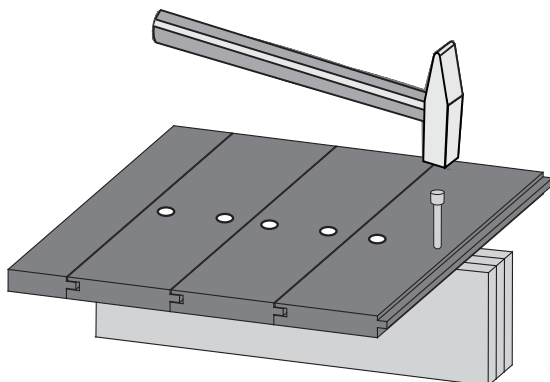
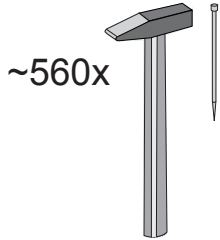

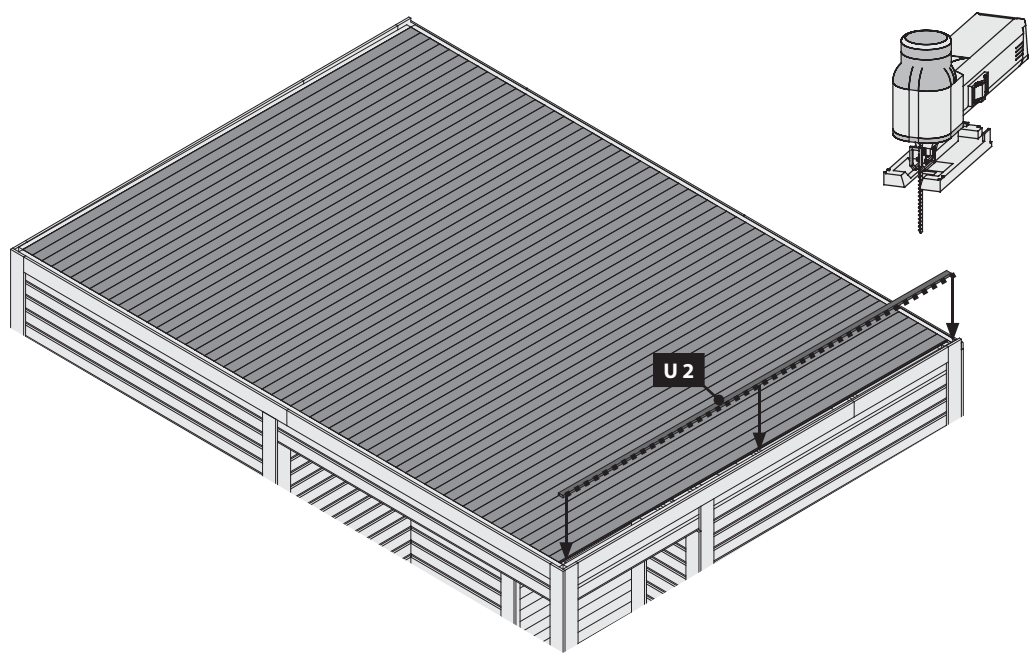

-  Bündig!
-  Flush!
-  Affleurement!
-  Gelijk!
-  I flugt!
-  Aras!
-  Combacia!
-  Stejný !

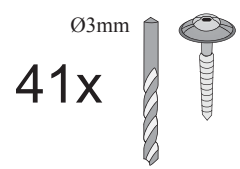
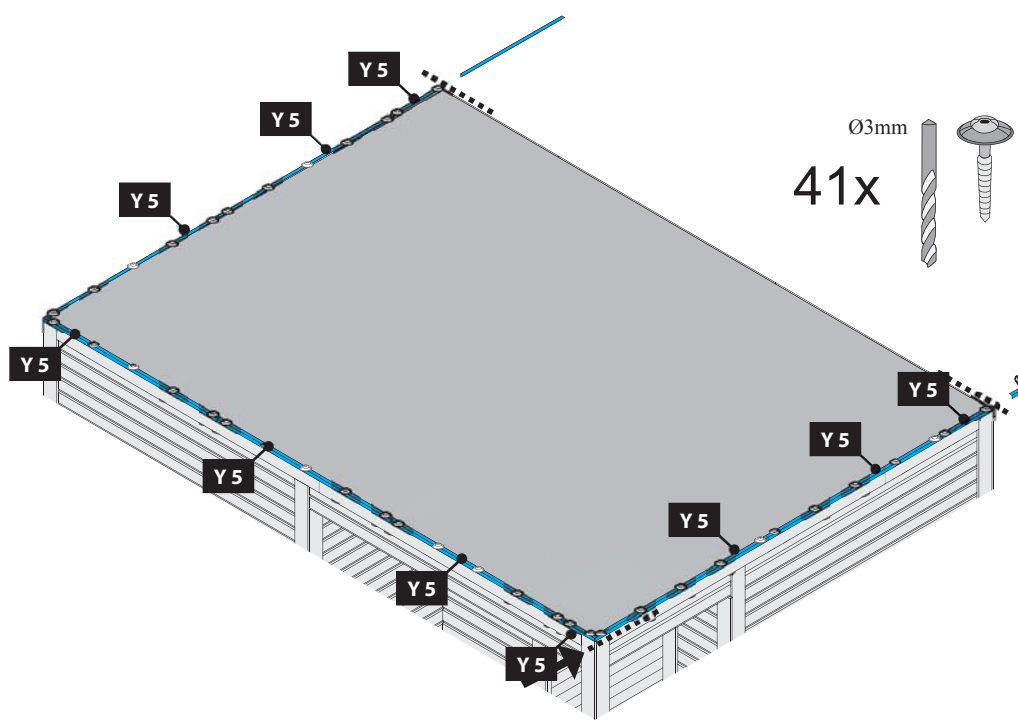
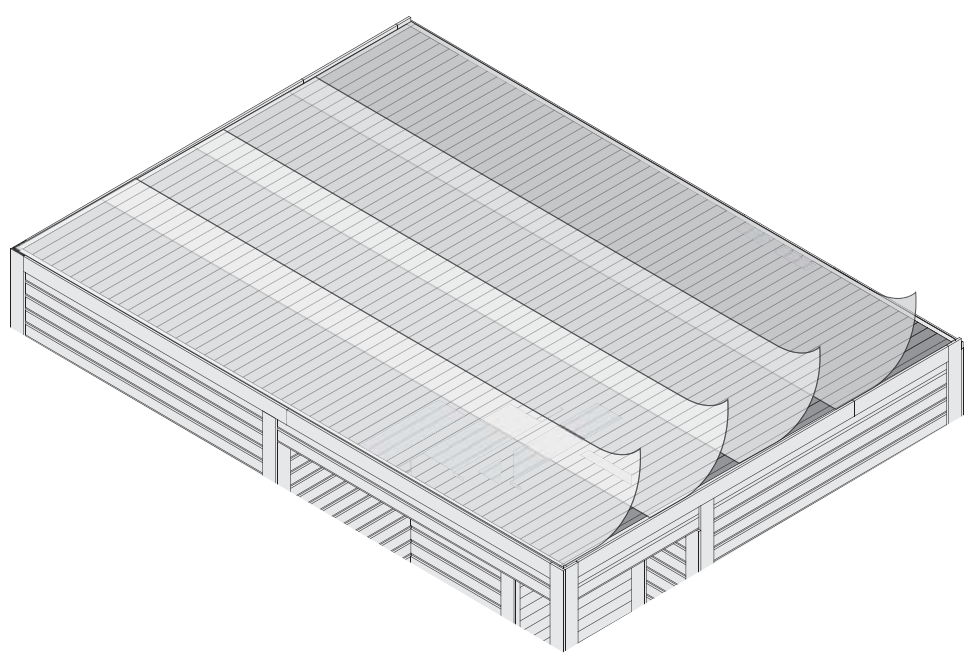
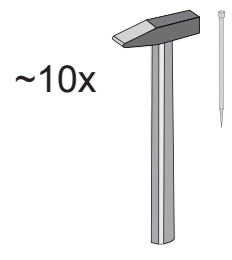

-  Bündig!
-  Flush!
-  Affleurement!
-  Gelijk!
-  I flugt!
-  Aras!
-  Combacia!
-  Stejný !

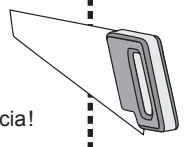

Verlegehinweis

Gardentop Stick Alu klebt auf Holzunterkonstruktionen, Metall, Bitumen, Beton, Mauerwerk und Kunststoffen (ausser PVC). Klebt nicht auf Silikon. Der Untergrund muss trocken, staub-, fettfrei und abriebfest sein.

Die Verarbeitungstemperatur sollte über 10 Grad Celsius betragen. Lagern Sie die Bahn bei kalten Jahreszeiten vor der Verarbeitung nicht im Freien. Eine optimale Verklebung erreichen Sie bei höheren Temperaturen. Achten Sie darauf, dass Sie Unebenheiten vor dem Aufbringen der Bahn ausgleichen. Vor der Verlegung sollte geprüft werden, ob das Produkt für den Einsatzbereich geeignet ist.

Bei verschmutztem Untergrund muss ein bituminöser Voranstrich (lösemittelhaltig oder lösemittelfrei) aufgebracht werden.

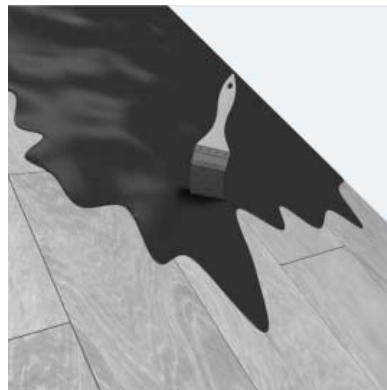

- Das Verlegen der Bahnen erfolgt längs oder quer mit einer Mindestüberlappung von 10 cm. Vor dem Abziehen der unterseitigen Folie, rollen Sie die Bahn ca. 2 m aus, um die Bahn seitlich auszurichten. Dann klappen Sie den Rollenanfang um und ziehen die Schutzfolie auf der Bahnenunterseite ca. 20 cm ab, um die Bahn so mit der Selbstklebefläche auf dem Untergrund zu fixieren (Bild 1).
- Anschließend rollen Sie die Bahn wieder zurück, bis zum verklebten/fixierten Rollenanfang.
- Rollen Sie die Bahn nun durch abziehen der unterseitigen Folie gleichmäßig aus (Bild 2) und achten Sie darauf, dass es keine Lufteinschlüsse gibt. Lufteinschlüsse sind gleichmäßig nach außen weg zu bürsten.
- Achten Sie besonders im Überdeckungsbereich darauf, dass eine gute Verklebung eintritt. Sie können die beste Klebewirkung mit einer Anpresswalze erreichen (Bild 3).

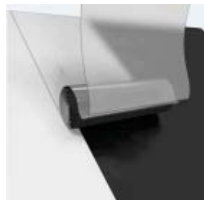
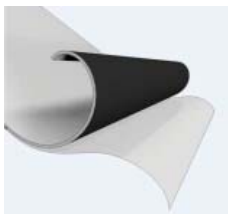

Gardentop STICK ALU 5 x 1m

Edition: 18/02/2016

EINSATZBEREICH / Produkt

Kaltselbstklebende, oberseitig alukaschierte Dachbahn, zur Dacheindeckung von untergeordneten Dächern, wie z. B. von Carports, Gartenhäusern, Geräteschuppen, usw.

ZUSAMMENSETZUNG

*Oberseitige Deckschicht
und Träger:*

UV – beständiger Aluminiumverbund

Unterseitige Deckschicht:

Thermoplastischer Bitumenklebstoff mit silikonisierter Abziehfolie

BESCHICHTUNG

Oberseite:

UV- beständiger Aluminiumverbund

Unterseite:

silikonisierte Folie

ABMESSUNGEN

Länge:

5 ($\pm 1\%$) x 1 ($\pm 1\%$) m

Dicke:

1,1 mm ($\pm 5\%$)

Gewicht / Dachbahn:

± 6 kg

VERPACKUNG

Rollen / Palette:

54 (270 m²),







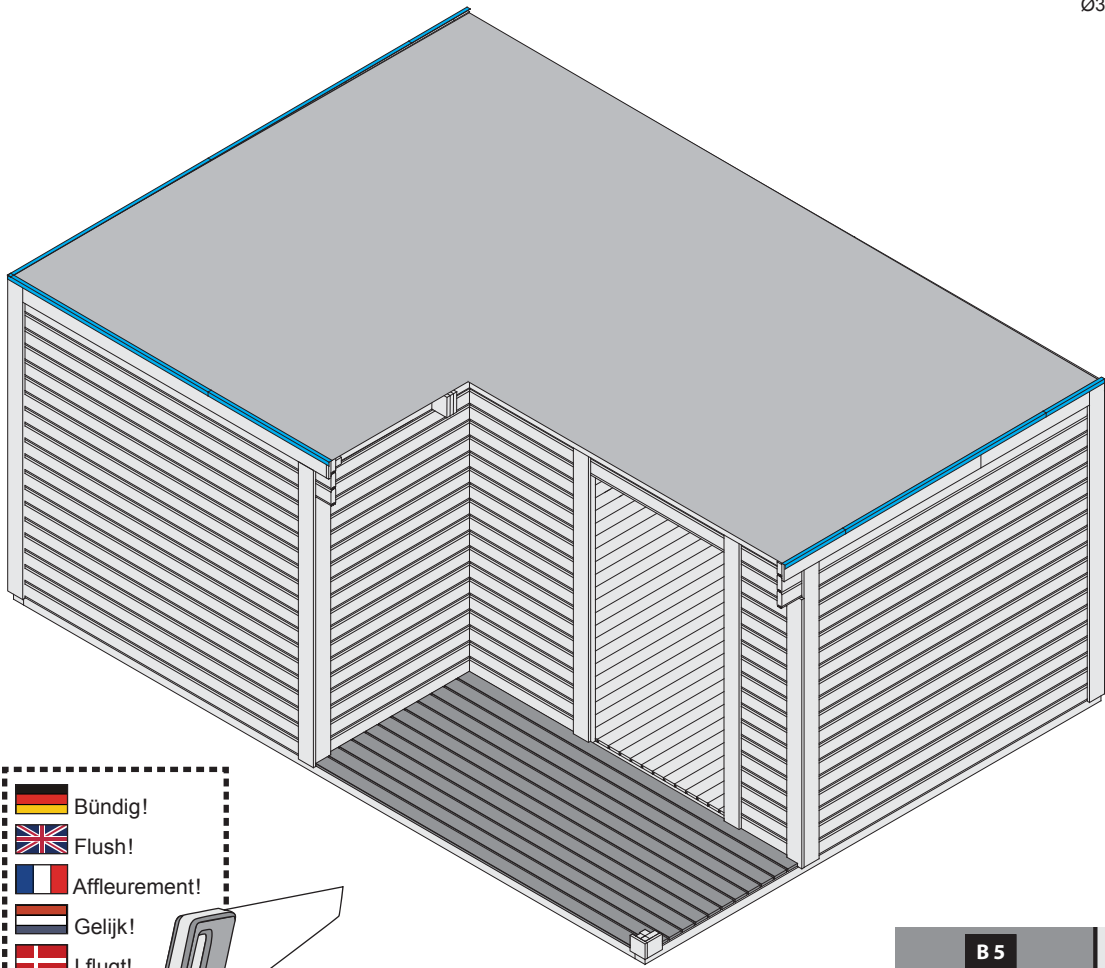
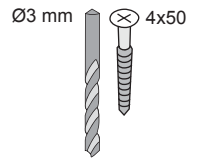

jede Rolle einzeln in Kartonverpackung, mit Aufdruck der Produktbezeichnung, -erklärung und Verlegehinweisen

TECHNISCHE INFO

	<i>Höchstzugkraft</i>		<i>Wärmestand-</i>
	<i>Länge</i>	<i>Breite</i>	<i>festigkeit bei 80°C</i>
<i>Minimalwerte</i>	$\geq 200N$	$\geq 200N$	$< 2mm$
	<i>Wasserdampf-</i>		<i>Brandklasse</i>
	<i>Durchlässigkeit sd</i>		
<i>Minimalwerte</i>	$> 1500 m$		<i>E</i>

120x

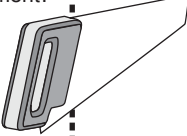
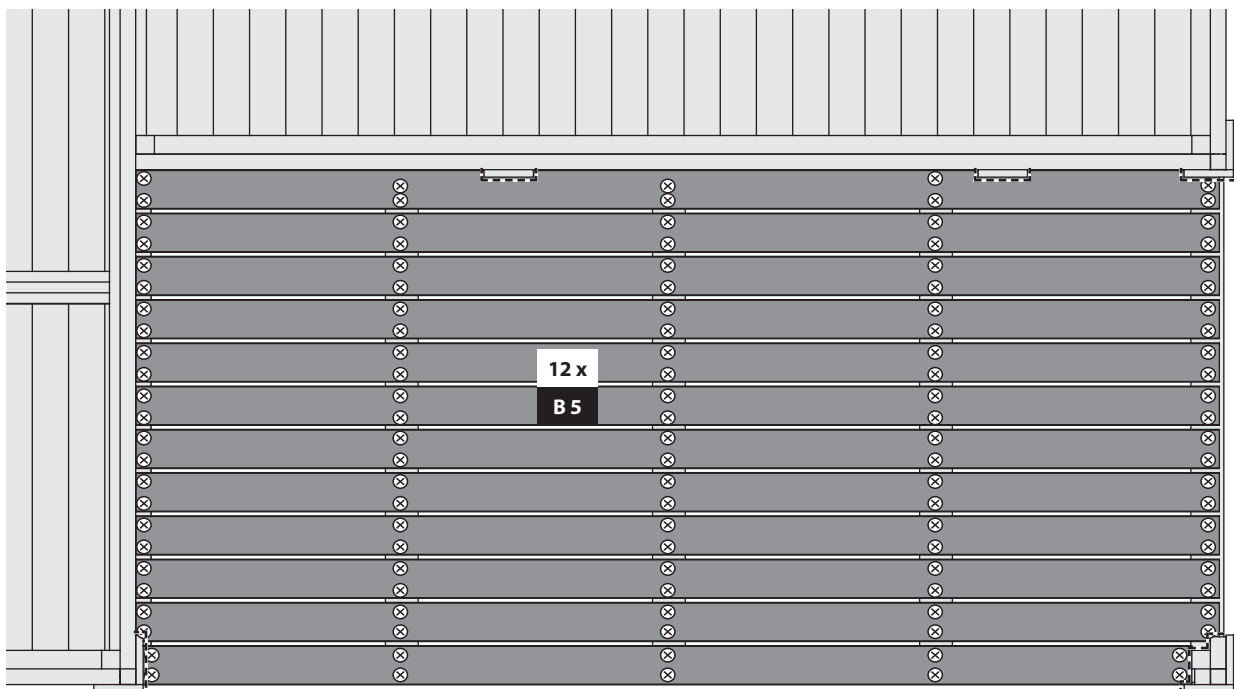
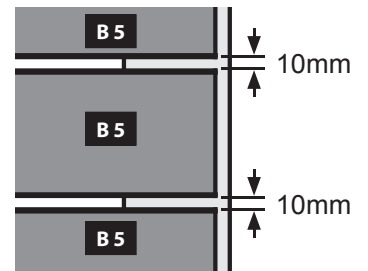

 Bündig!
 Flush!
 Affleurement!
 Gelijk!
 I flugt!
 Aras!
 Combacia!
 Stejný !

33

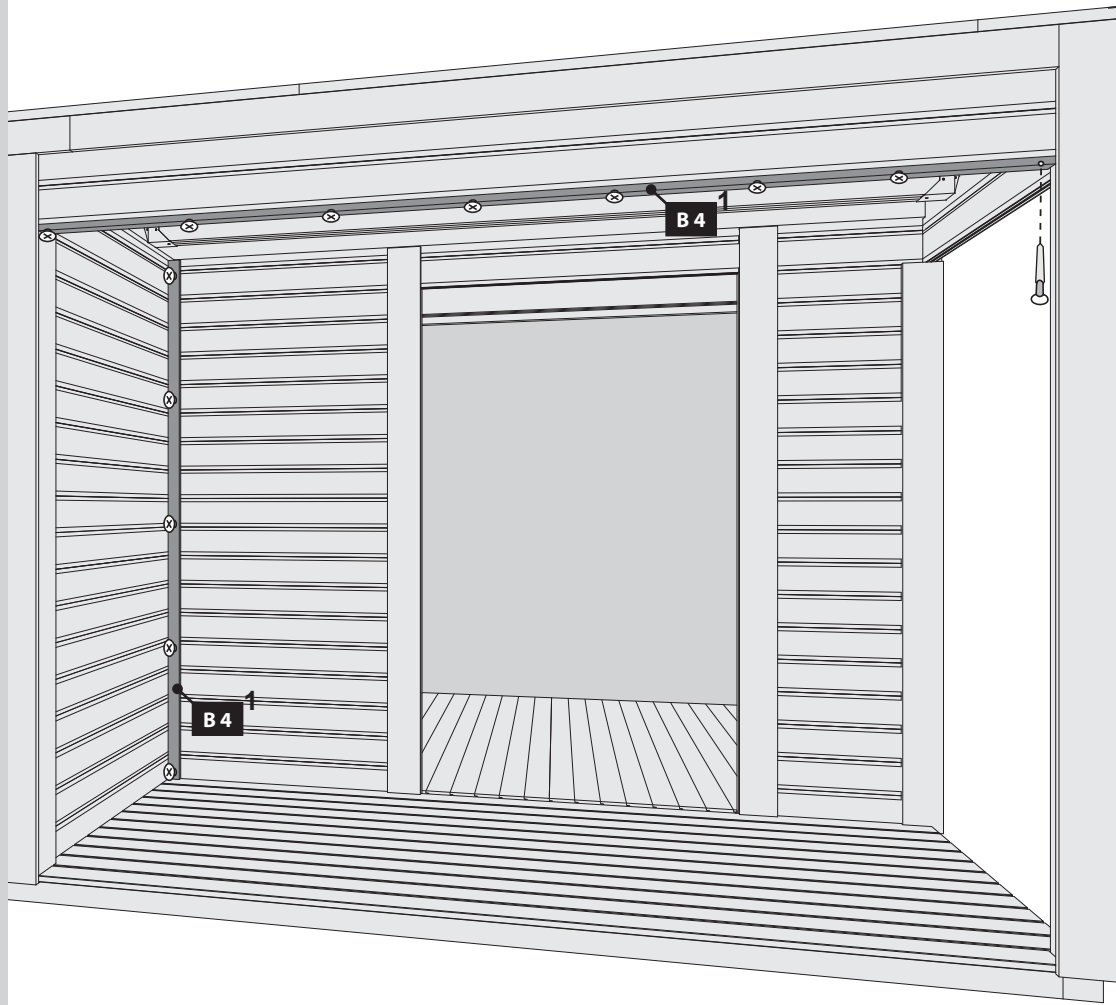

13x
 Ø3 mm 4x35

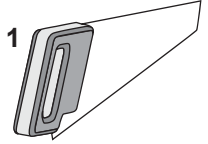
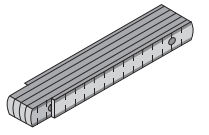

34

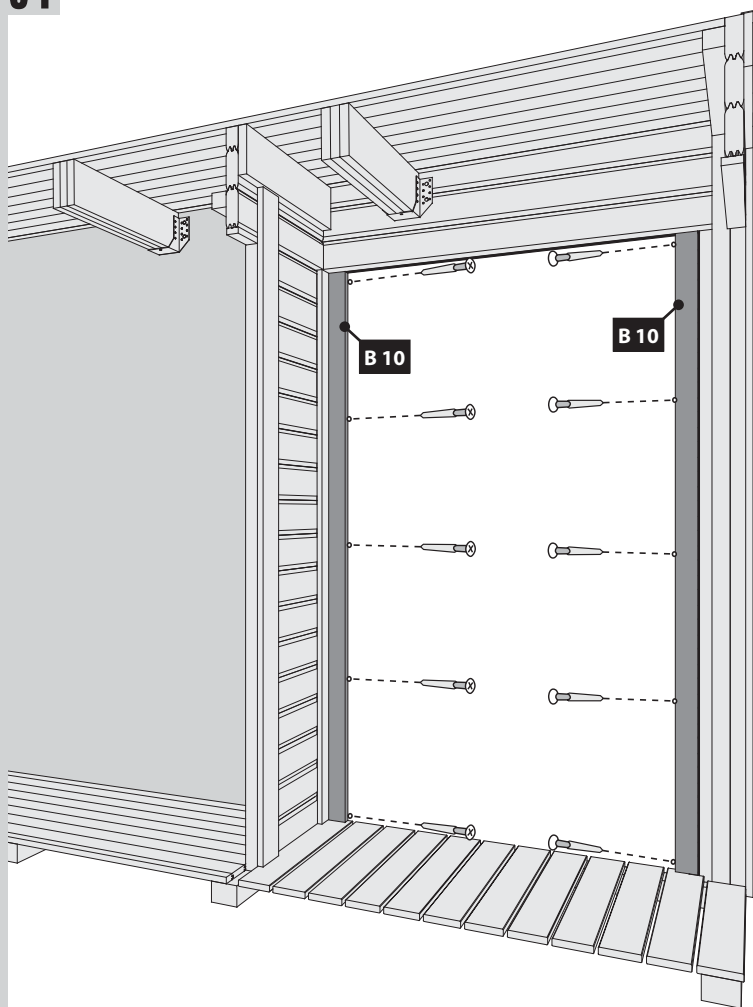

10x
 Ø3 mm 4x50

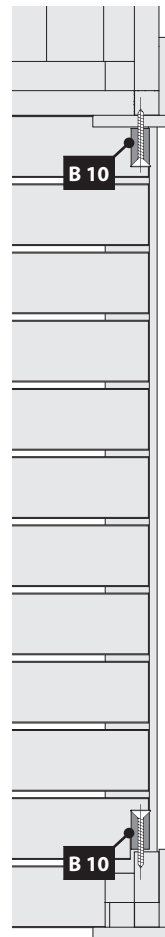

-  Draufsicht
-  Top view
-  vue de dessus
-  bovenaanzicht
-  vista desde arriba
-  vista desde arriba
-  vista dall'alto
-  púdorys

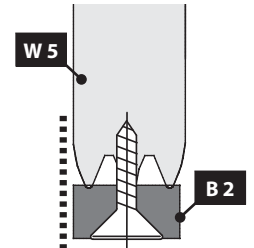
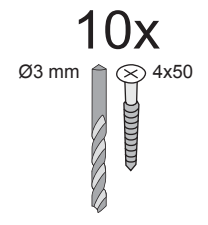
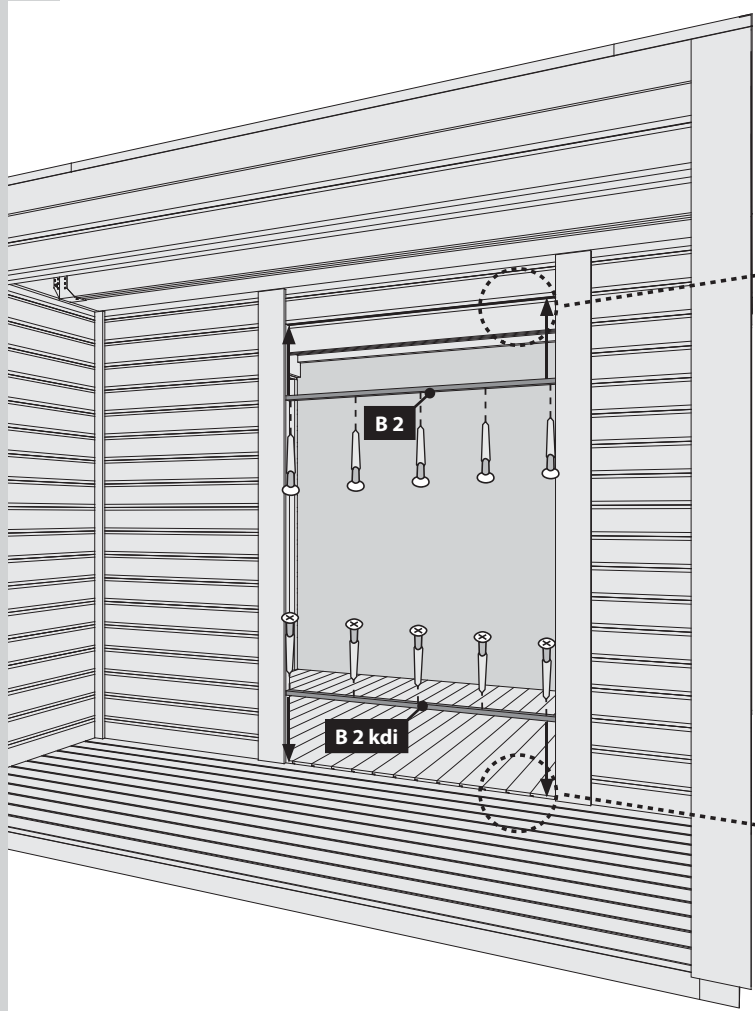
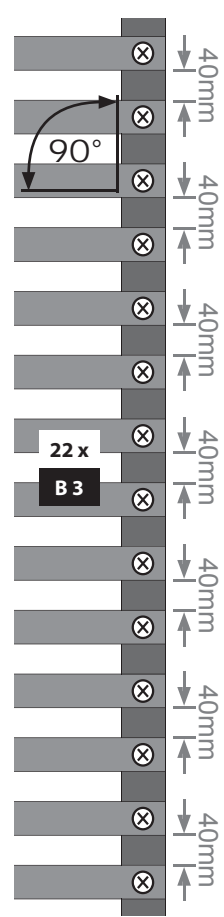
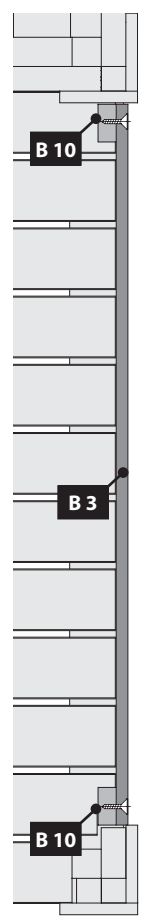
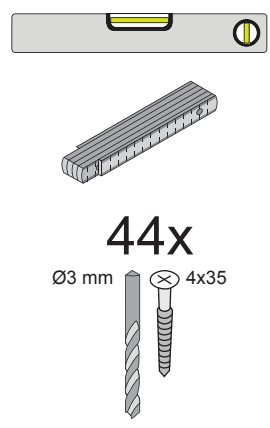
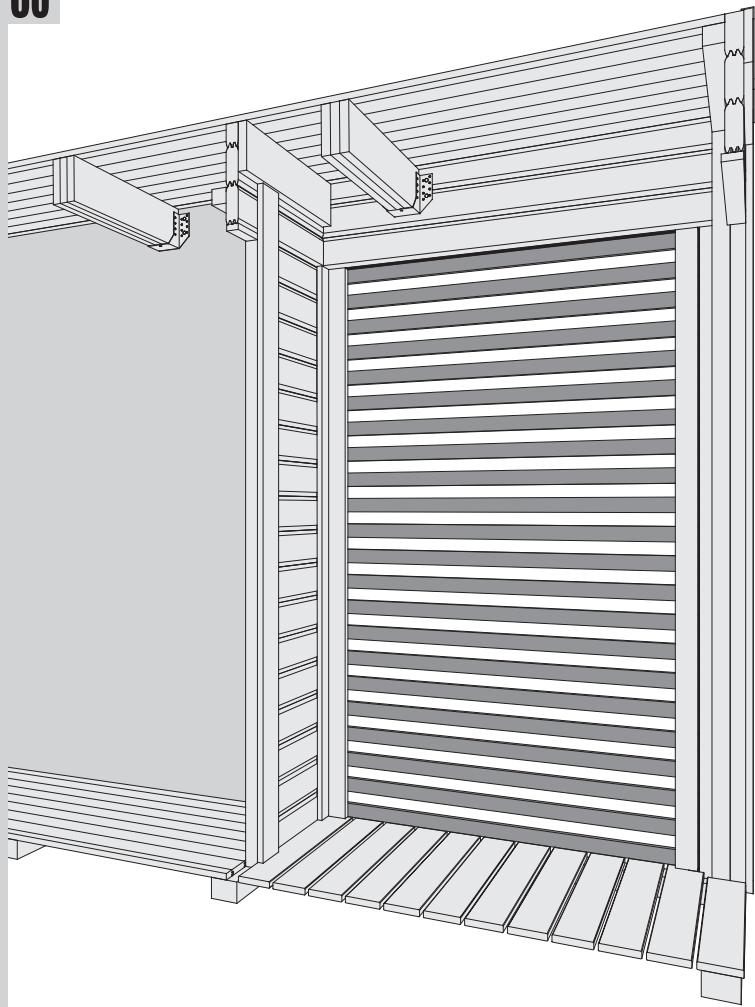

-  Bündig!
-  Flush!
-  Affleurement!
-  Gelijk!
-  I flugt!
-  Aras!
-  Combacia!
-  Stejný!

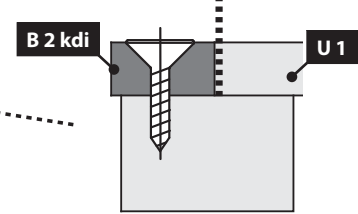

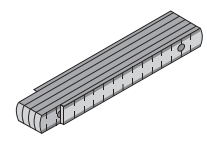
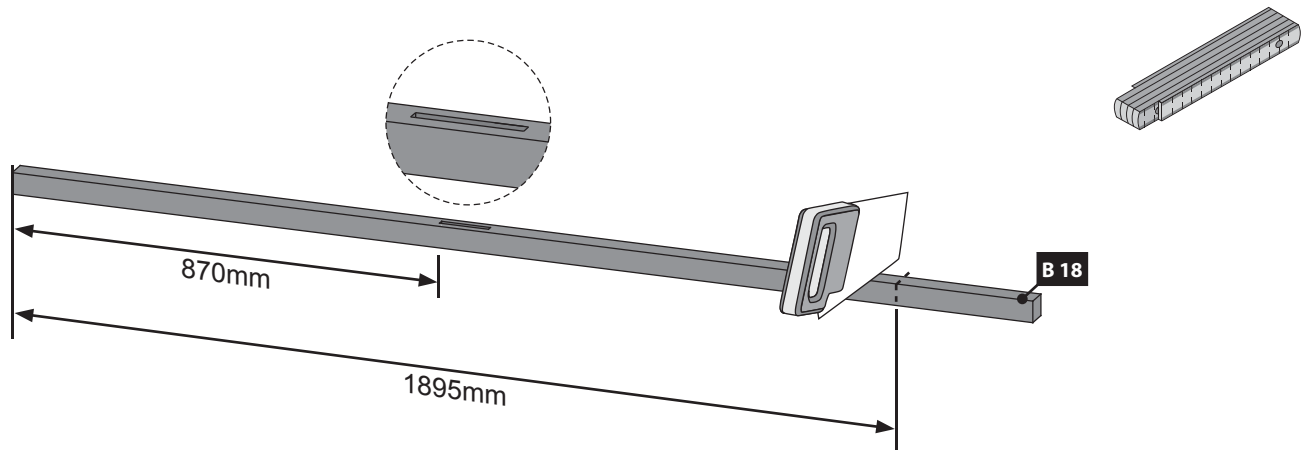

13x
Ø3 mm 4x70

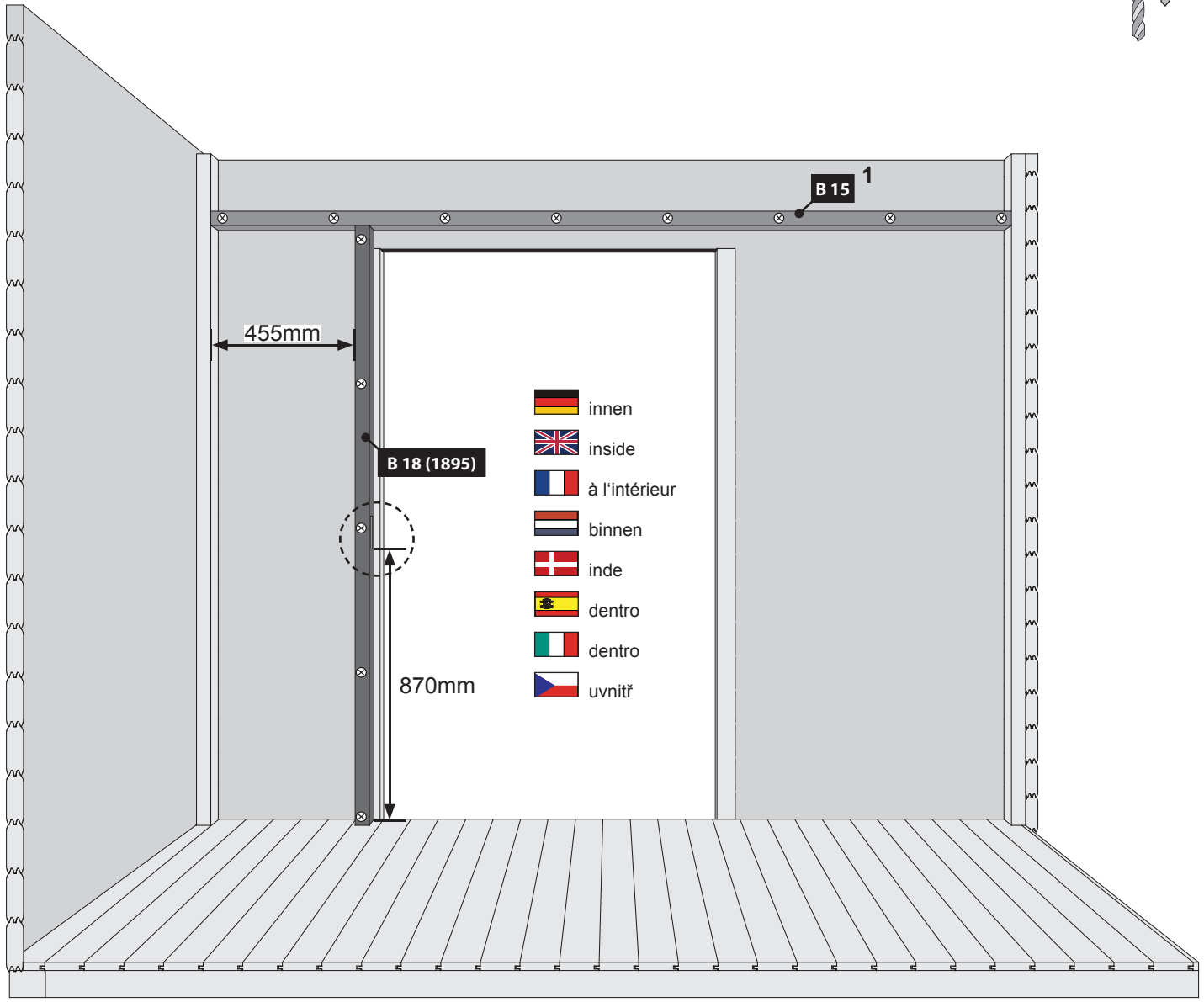

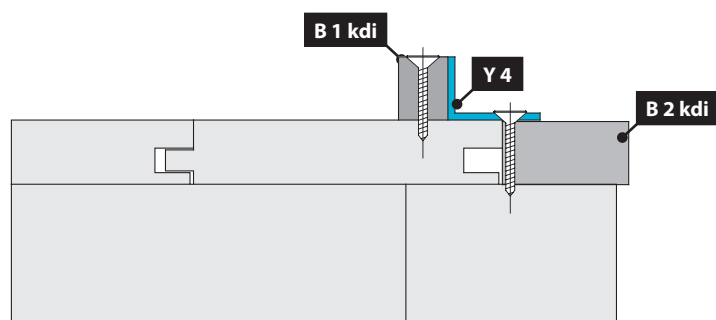
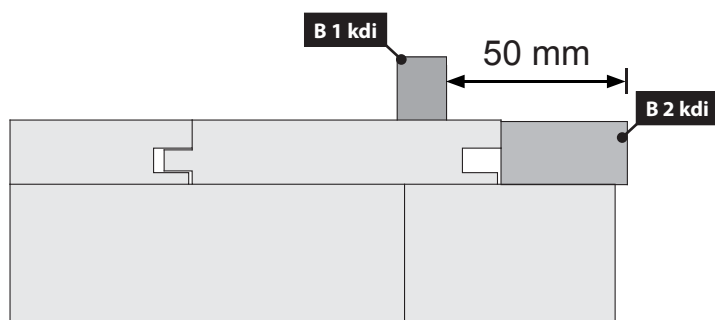
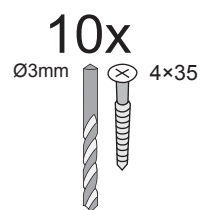
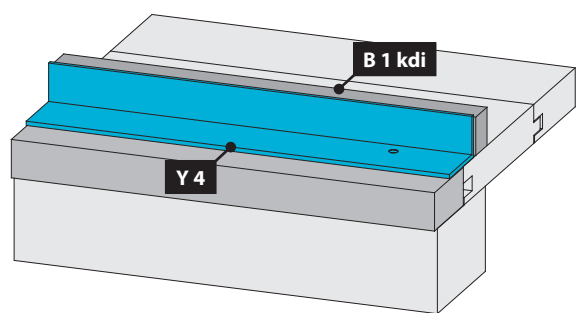
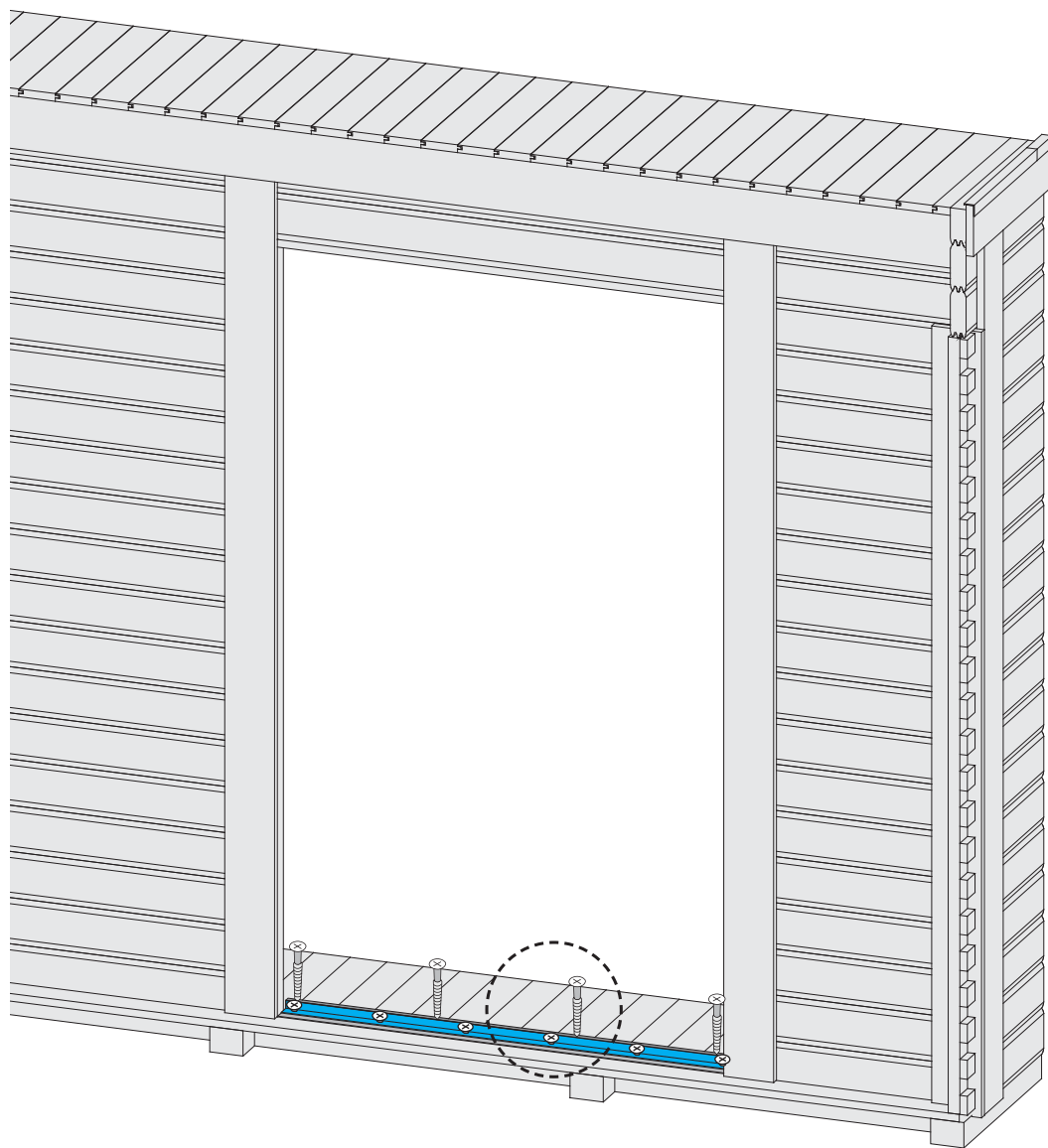

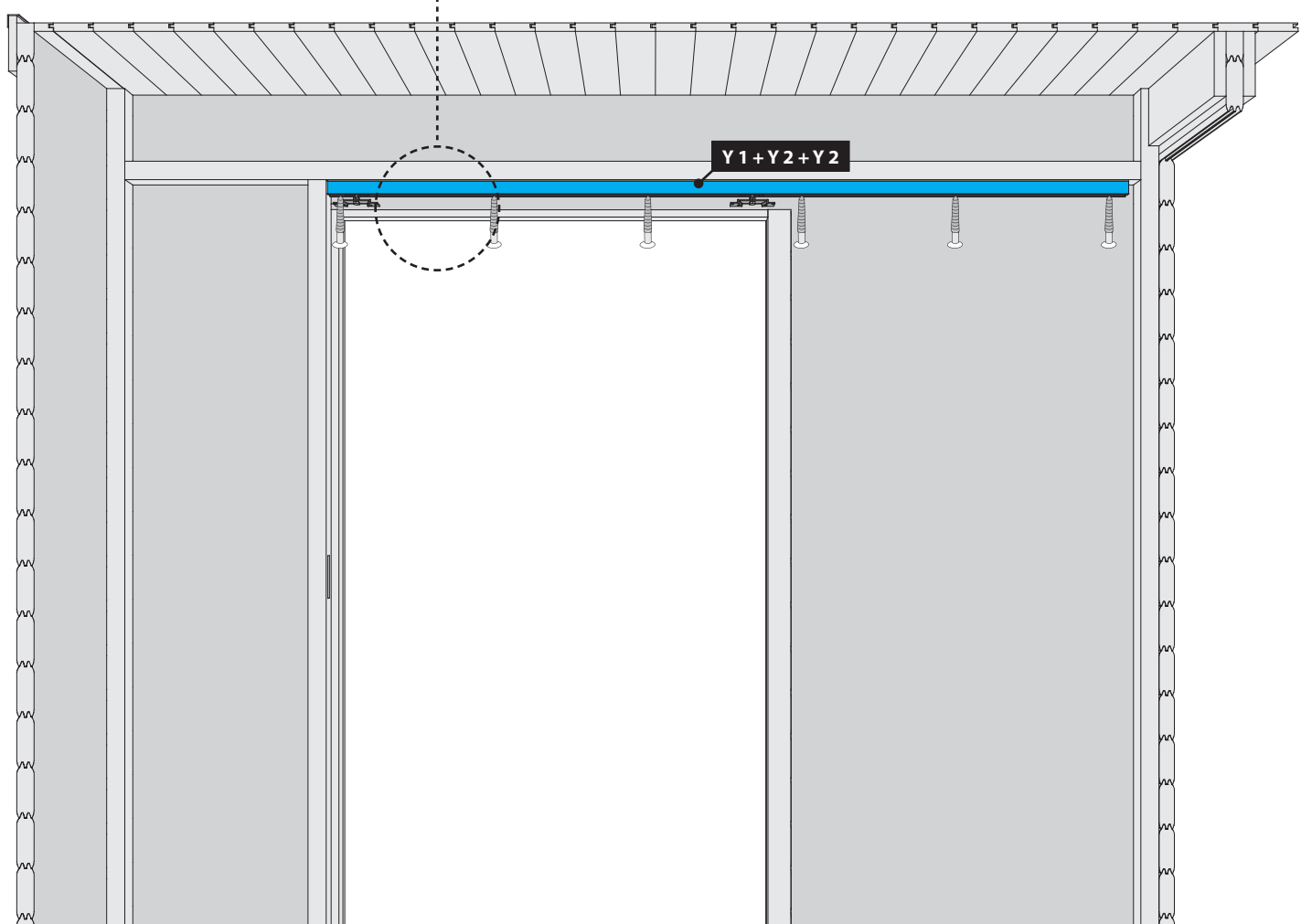
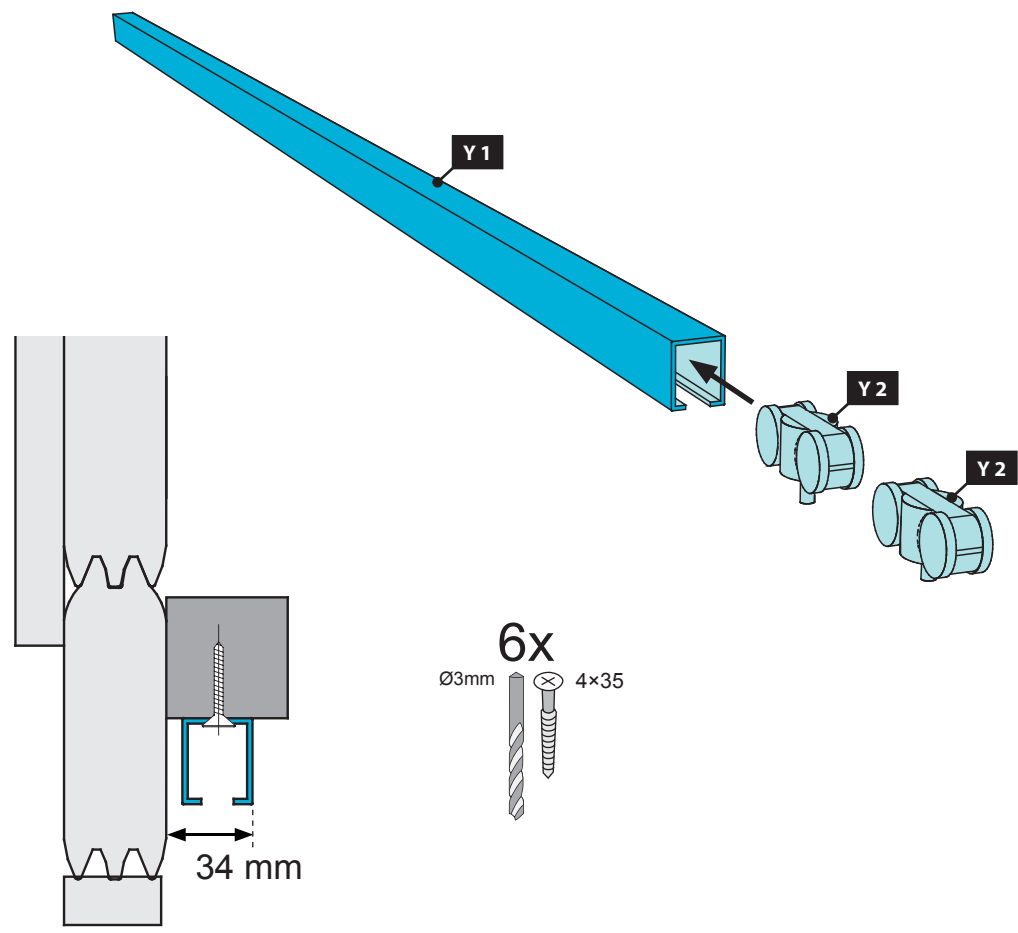

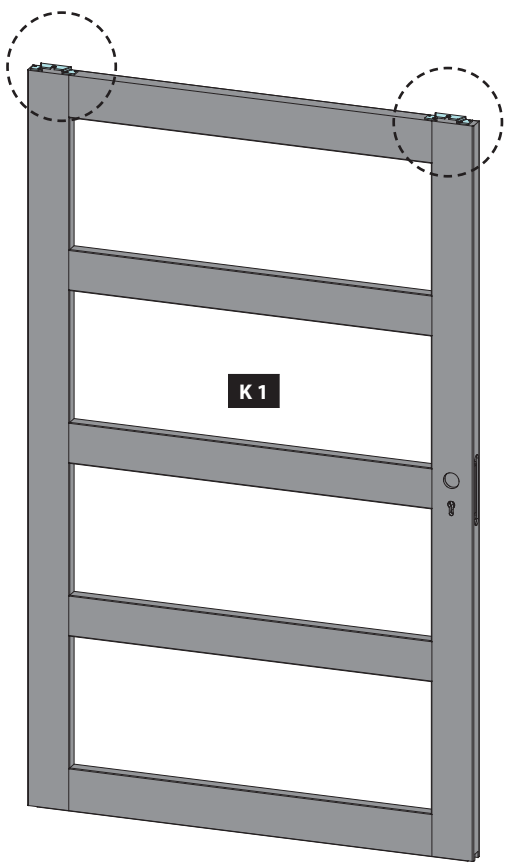

8x
 Ø3mm 4x35

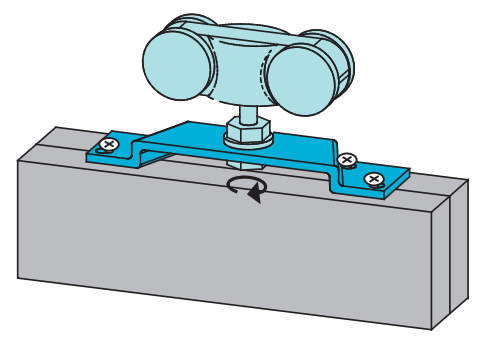
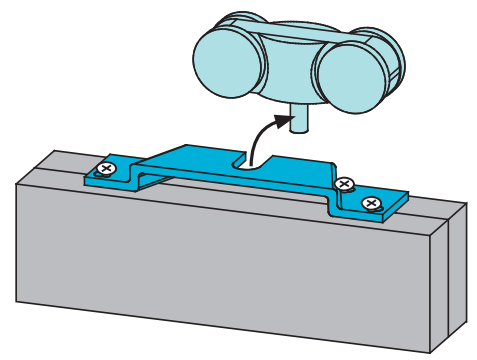
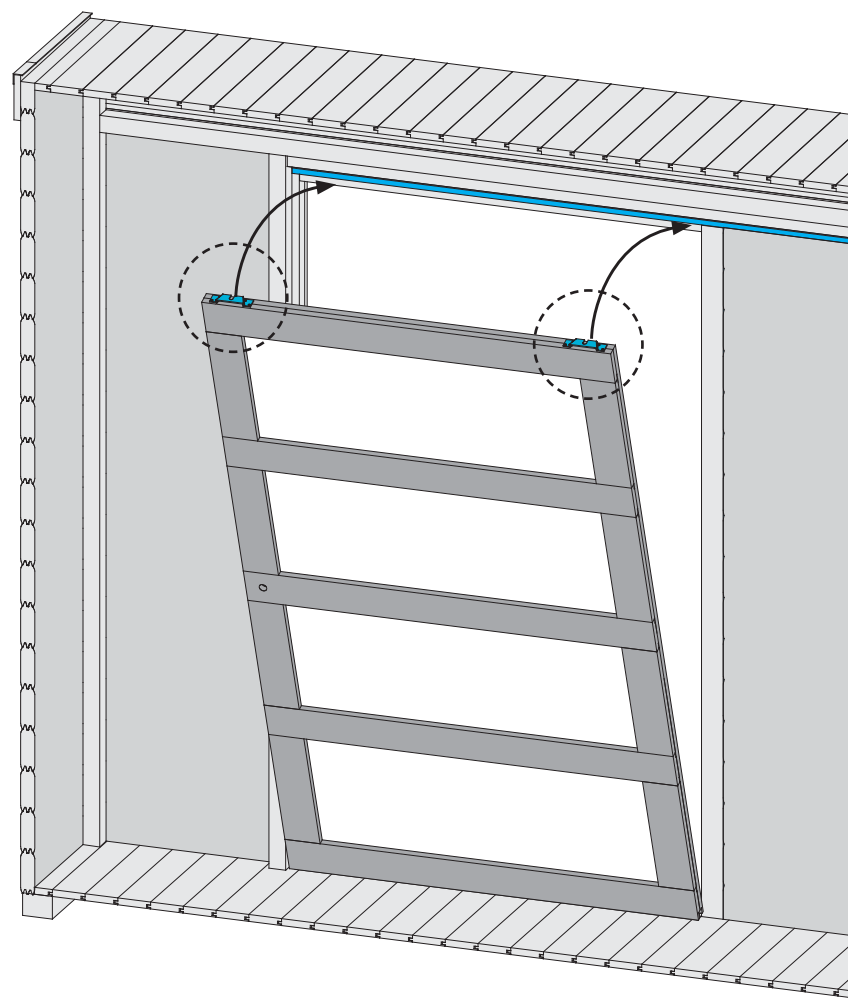
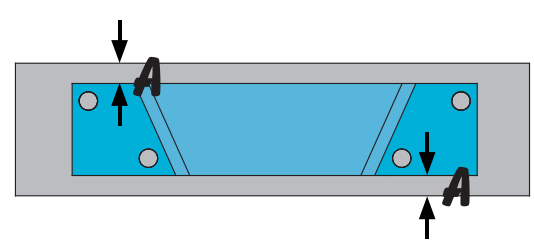
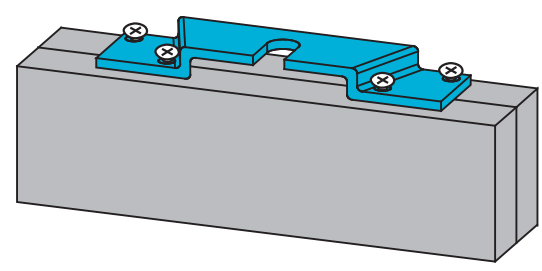

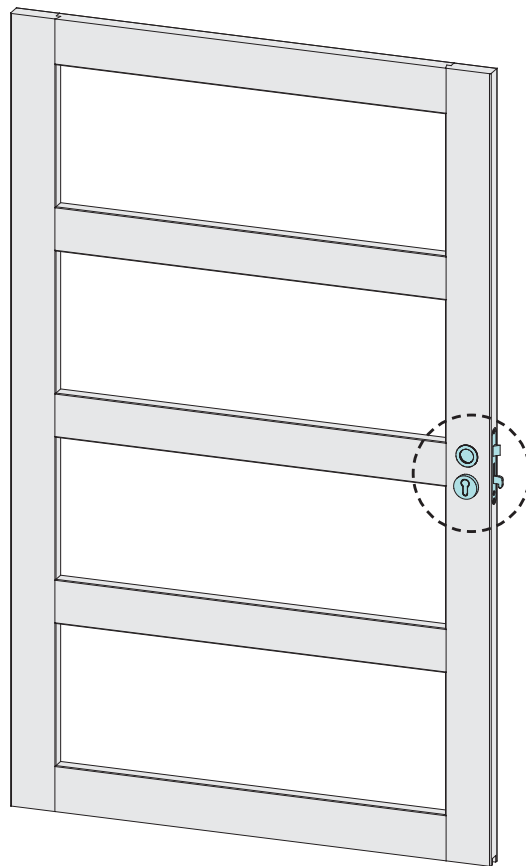

-  außen
-  outside
-  à l'extérieur
-  buiten
-  udenfor
-  fuera
-  al di fuori
-  vně

